

Index

Page



ON-OFF Switches for Panel Mounting

306



ON-OFF Switches for Single Hole Mounting

307



ON-OFF Switches for Base Mounting with Door Clutch

308



ON-OFF Switches for Distribution Boards

309



Main Switches for Panel Mounting

310



Main Switches for Single Hole Mounting

311



Main Switches for Base Mounting with Door Clutch

312



Main Switches for Distribution Boards

313



Main Switches in Plastic Enclosure

314



Technical Datas
Approvals
Dimensions

315

319

325

Contactors, Motor-Starter

Circuit Breakers

Manual Motor-Starters

Switches

AC-Main Switches

DC-Switch Disconnector

Push Buttons

Representatives, Suppliers

Ratings				DC-Switch Disconnectors			
Type	I _{th} open A	DC21B(DC-PV1) 4 poles in series A	at U _e V	Design			
				Panel mounting 4-hole mounting IP66 ¹⁾ Type 3R	Single hole mounting Ø22,5mm IP66 ¹⁾ Type 4X	Base mounting w. door coupling IP66 ¹⁾ Type 4X	Modular switch IP40 ¹⁾ Open Type
LS16	16	16	1000	.. E Z(O) VZV SMA ..
LS25	25	25	1000	.. E Z(O) VZV SMA ..
LS32	32	32	1000	.. E Z(O) VZV SMA ..
LS40	40	25	1000	.. E ..	-	.. VZV SMA ..
LS55	55	32	1000	.. E ..	-	.. VZV SMA ..

Switch Disconnectors for Photovoltaic

Switch disconnectors „LS..“ are switch gears for interrupting the DC/AC-Inverter from the solar-panels. Photovoltaic-installations have to be equipped with DC-isolators according to IEC 60364-7-712.

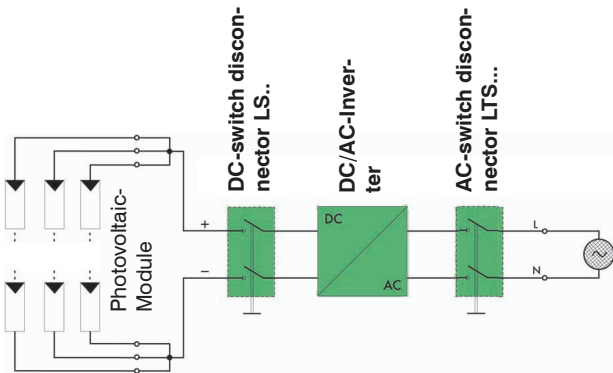

Switch disconnectors „LS..“ ensures a reliable switching up to 85A with 1500V in the category DC21B (DC-PV1).

The construction of the contacts and the material selection guarantee that no oxidation (small switching frequency) develops, and is thus prevented inadmissible heating-up.

The switch disconnector has 2, 4, 6 or 8 contacts, by serial or parallel wiring of the contacts the contact rating will be increased.

The switching speed at the manually operated handle does not have an effect on the switching attitude of the contacts.

Switching programs

Type	2-pole	2+2-pole 2 poles in series +2 poles parallel	4-pole	4-pole with jumpers Input on top Output bottom	4-pole with jumpers Input and Output bottom	4-pole with jumpers Input and Output on top
LS16	.. A2	.. A2+2	..A4(2 x A2)	.. A4B	.. A4O	.. A4U
LS25	.. A2	.. A2+2	..A4(2 x A2)	.. A4B	.. A4O	.. A4U
LS32	.. A2	.. A2+2	..A4(2 x A2)	.. A4B	.. A4O	.. A4U
LS40	.. A2	.. A2+2	..A4(2 x A2)	.. A4B	.. A4O	.. A4U
LS55	.. A2	.. A2+2	..A4(2 x A2)	.. A4B	.. A4O	.. A4U

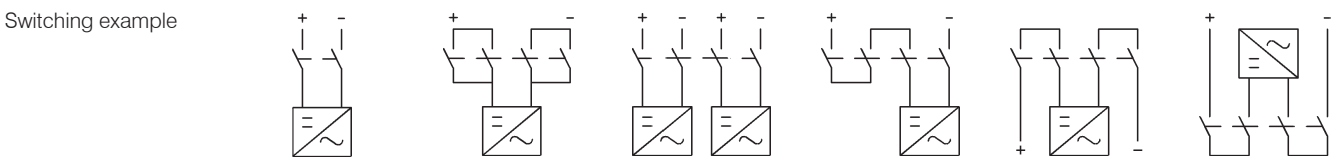
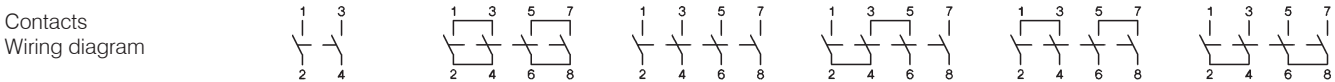

Ordering

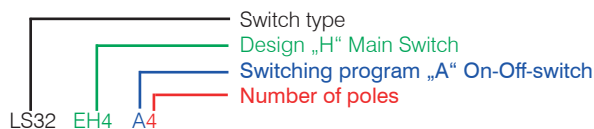

1) Protection in front and built in

DC-Main Switch

Panel mounting
Four-hole mounting
IP66¹⁾ Type 3R



Single hole mounting
Ø22,5mm IP66¹⁾
Type 4X



Base mounting
with door coupling
IP66¹⁾ Type 4X



Modular
switch IP40¹⁾
Open Type



Plastic enclosed
PFL..IP67 Type 4X



.. EH4 Z(O)H1 VZVH4 SMAH1 PFLH4 ..
.. EH4 Z(O)H1 VZVH4 SMAH1 PFLH4 ..
.. EH4 Z(O)H1 VZVH4 SMAH1 PFLH4 ..
.. EH4 ..	-	.. VZVH4 SMAH1 PFLH4 ..
.. EH4 ..	-	.. VZVH4 SMAH1 PFLH4 ..

Technical data for DC, according to IEC 60947-3, VDE0660, more data see page 309

Type		DC21B (DC-PV1)								DC22B			
		500V	600V	700V	800V	900V	1000V	1200V	1500V	500V	600V	800V	1000V
2 poles in series 	LS16 ..	16A	16A	16A	16A	16A	10A	7A	3A	7A	5,5A	2A	1A
	LS25..	25A	25A	25A	19A	17A	11,5A	8,5A	5A	8A	6A	2,5A	1,5A
	LS32 ..	32A	32A	32A	21A	18A	13A	10A	6A	9A	6,5A	3A	2A
	LS40 ..	40A	40A	37A	35A	31A	29A	11A	7,5A	-	-	-	-
	LS55..	55A	55A	55A	55A	43A	36A	17A	10A	-	-	-	-
2 poles in series + 2 parallel 	LS16 ..	29A	29A	22A	17A	16A	10A	7A	3A	-	-	-	-
	LS25..	45A	36A	27A	19A	17A	12A	9A	5A	-	-	-	-
	LS32 ..	58A	55A	32A	21A	18A	13A	10A	6A	-	-	-	-
	LS40 ..	72A	72A	49A	42A	31A	29A	11A	7,5A	-	-	-	-
	LS55..	85A	85A	77A	63A	43A	36A	17A	10A	-	-	-	-
4 poles in series 	LS16 ..	16A	16A	16A	16A	16A	16A	16A	16A	16A	16A	11,5A	8A
	LS25..	25A	25A	25A	25A	25A	25A	25A	25A	25A	25A	12A	9A
	LS32 ..	32A	32A	32A	32A	32A	32A	32A	32A	32A	32A	27,5A	10A
	LS40 ..	40A	40A	40A	40A	40A	40A	40A	40A	40A	40A	-	-
	LS55..	55A	55A	55A	55A	55A	55A	55A	55A	55A	55A	-	-
4 poles in series + 2 parallel 	LS16 ..	29A	29A	29A	29A	29A	29A	29A	20A	-	-	-	-
	LS25..	45A	45A	45A	45A	45A	45A	45A	26A	-	-	-	-
	LS32 ..	58A	58A	58A	58A	58A	58A	50A	32A	-	-	-	-
	LS40 ..	72A	72A	72A	72A	72A	72A	56A	42A	-	-	-	-
	LS55 ..	85A	85A	85A	85A	85A	85A	65A	55A	-	-	-	-

Switching programs

Type	6-pole	3+2-pole 3 poles in series +2 poles parallel	8-pole	4+2-pole 4 poles in series +2 poles parallel
LS16	...A6	.. A3+2	...A8	.. A4+2
LS25	...A6	.. A3+2	...A8	.. A4+2
LS32	...A6	.. A3+2	...A8	.. A4+2
LS40	...A6	.. A3+2	...A8	.. A4+2
LS55	...A6	.. A3+2	...A8	.. A4+2

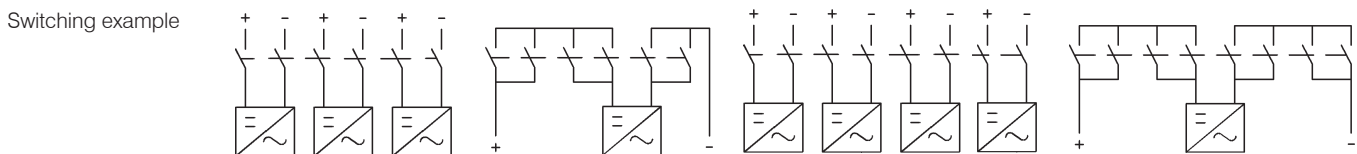
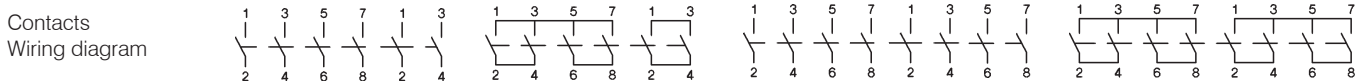

Insulated Jumper LSV.. for series and parallel switching of contacts



Type	Pack	Weight
LS16, LS25, LS32	LSV-B1 100	6,6 g/pc.
LS40, LS55	LSV-B2 100	9,64 g/pc.

ON-OFF Switches for Panel Mounting, Escutcheon plate 64[□], IP66



DC21B / DC-PV1 600V DC	1000V DC	Poles in series	Number of Strings	Type	Pack pcs	Weight kg/pcs.
16A	10A	2	1	LS16 E A2	1	0,20
25A	11,5A	2	1	LS25 E A2	1	0,20
32A	13A	2	1	LS32 E A2	1	0,20
40A	29A	2	1	LS40 E A2	1	0,41
55A	36A	2	1	LS55 E A2	1	0,41

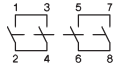

29A	10A	2	1	LS16 E A2+2	1	0,25
36A	11,5A	2	1	LS25 E A2+2	1	0,25
55A	13A	2	1	LS32 E A2+2	1	0,25
68A	29A	2	1	LS40 E A2+2	1	0,54
85A	36A	2	1	LS55 E A2+2	1	0,54

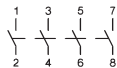

16A	10A	2	2	LS16 E A4	1	0,23
25A	11,5A	2	2	LS25 E A4	1	0,23
32A	13A	2	2	LS32 E A4	1	0,23
40A	29A	2	2	LS40 E A4	1	0,49
55A	36A	2	2	LS55 E A4	1	0,49

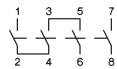

16A	16A	4	1	LS16 E A4B	1	0,24
25A	25A	4	1	LS25 E A4B	1	0,24
32A	32A	4	1	LS32 E A4B	1	0,24
40A	40A	4	1	LS40 E A4B	1	0,52
55A	55A	4	1	LS55 E A4B	1	0,52

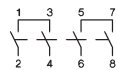

16A	16A	4	1	LS16 E A4O	1	0,24
25A	25A	4	1	LS25 E A4O	1	0,24
32A	32A	4	1	LS32 E A4O	1	0,24
40A	40A	4	1	LS40 E A4O	1	0,52
55A	55A	4	1	LS55 E A4O	1	0,52

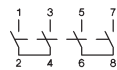

16A	16A	4	1	LS16 E A4U	1	0,24
25A	25A	4	1	LS25 E A4U	1	0,24
32A	32A	4	1	LS32 E A4U	1	0,24
40A	40A	4	1	LS40 E A4U	1	0,52
55A	55A	4	1	LS55 E A4U	1	0,52

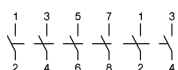

16A	10A	2	3	LS16 E A6	1	0,36
25A	11,5A	2	3	LS25 E A6	1	0,36
32A	13A	2	3	LS32 E A6	1	0,36
40A	29A	2	3	LS40 E A6	1	0,99
55A	36A	2	3	LS55 E A6	1	0,99

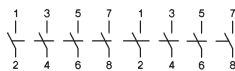

16A	10A	2	4	LS16 E A8	1	0,41
25A	11,5A	2	4	LS25 E A8	1	0,41
32A	13A	2	4	LS32 E A8	1	0,41
40A	29A	2	4	LS40 E A8	1	1,09
55A	36A	2	4	LS55 E A8	1	1,09

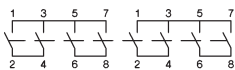

29A	29A	4	1	LS16 E A4+2	1	0,46
45A	45A	4	1	LS25 E A4+2	1	0,46
58A	58A	4	1	LS32 E A4+2	1	0,46
72A	72A	4	1	LS40 E A4+2	1	1,20
85A	85A	4	1	LS55 E A4+2	1	1,20

Extended Switch Shaft for all switches for panel mounting

type suffix

+VW“x”

x = panel thickness

ON-OFF Switches for Single Hole Mounting Ø22mm, Escutcheon plate 48², IP66 US Type 4X



DC21B / DC-PV1 600V DC	DC 1000V DC	Poles in series	Number of Strings	Type	Pack pcs	Weight kg/pcs.
16A	10A	2	1	LS16 Z A2	1	0,21
25A	11,5A	2	1	LS25 Z A2	1	0,21
32A	13A	2	1	LS32 Z A2	1	0,21

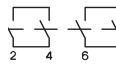

29A	10A	2	1	LS16 Z A2+2	1	0,26
36A	11,5A	2	1	LS25 Z A2+2	1	0,26
55A	13A	2	1	LS32 Z A2+2	1	0,26

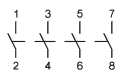

16A	10A	2	2	LS16 Z A4	1	0,23
25A	11,5A	2	2	LS25 Z A4	1	0,23
32A	13A	2	2	LS32 Z A4	1	0,23

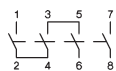

16A	16A	4	1	LS16 Z A4B	1	0,25
25A	25A	4	1	LS25 Z A4B	1	0,25
32A	32A	4	1	LS32 Z A4B	1	0,25

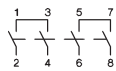

16A	16A	4	1	LS16 Z A4O	1	0,25
25A	25A	4	1	LS25 Z A4O	1	0,25
32A	32A	4	1	LS32 Z A4O	1	0,25

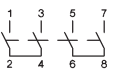

16A	16A	4	1	LS16 Z A4U	1	0,25
25A	25A	4	1	LS25 Z A4U	1	0,25
32A	32A	4	1	LS32 Z A4U	1	0,25

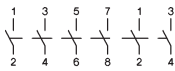

16A	10A	2	3	LS16 Z A6	1	0,38
25A	11,5A	2	3	LS25 Z A6	1	0,38
32A	13A	2	3	LS32 Z A6	1	0,38

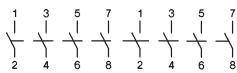

16A	10A	2	4	LS16 Z A8	1	0,43
25A	11,5A	2	4	LS25 Z A8	1	0,43
32A	13A	2	4	LS32 Z A8	1	0,43

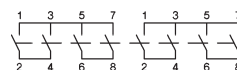

29A	29A	4	1	LS16 Z A4+2	1	0,48
45A	45A	4	1	LS25 Z A4+2	1	0,48
58A	58A	4	1	LS32 Z A4+2	1	0,48

ON-OFF Switches for Single Hole Mounting Ø22mm, without Escutcheon plate, IP66, US Typ 4X



Replace at the Type „Z“ with „ZO“ **LS.. ZO A.**

ON-OFF Switches f. Base Mounting w. Door Clutch f. Single Hole, Plate 64³, IP66, US Type 4X

DC21B / DC-PV1 Poles Number of **Type** Pack Weight
 600V DC 1000V DC in series Strings



16A	10A	2	1	LS16 VZV A2	1	0,22
25A	11,5A	2	1	LS25 VZV A2	1	0,22
32A	13A	2	1	LS32 VZV A2	1	0,22
40A	29A	2	1	LS40 VZV A2	1	0,51
55A	36A	2	1	LS55 VZV A2	1	0,51

Depth is adjustable
see page 317

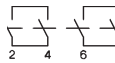

29A	10A	2	1	LS16 VZV A2+2	1	0,27
36A	11,5A	2	1	LS25 VZV A2+2	1	0,27
55A	13A	2	1	LS32 VZV A2+2	1	0,27
68A	29A	2	1	LS40 VZV A2+2	1	0,55
85A	36A	2	1	LS55 VZV A2+2	1	0,55

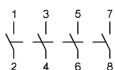

16A	10A	2	2	LS16 VZV A4	1	0,25
25A	11,5A	2	2	LS25 VZV A4	1	0,25
32A	13A	2	2	LS32 VZV A4	1	0,25
40A	29A	2	2	LS40 VZV A4	1	0,56
55A	36A	2	2	LS55 VZV A4	1	0,56

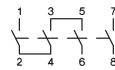

16A	16A	4	1	LS16 VZV A4B	1	0,26
25A	25A	4	1	LS25 VZV A4B	1	0,26
32A	32A	4	1	LS32 VZV A4B	1	0,26
40A	40A	4	1	LS40 VZV A4B	1	0,58
55A	55A	4	1	LS55 VZV A4B	1	0,58

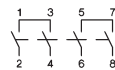

16A	16A	4	1	LS16 VZV A4O	1	0,26
25A	25A	4	1	LS25 VZV A4O	1	0,26
32A	32A	4	1	LS32 VZV A4O	1	0,26
40A	40A	4	1	LS40 VZV A4O	1	0,58
55A	55A	4	1	LS55 VZV A4O	1	0,58

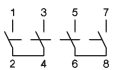

16A	16A	4	1	LS16 VZV A4U	1	0,26
25A	25A	4	1	LS25 VZV A4U	1	0,26
32A	32A	4	1	LS32 VZV A4U	1	0,26
40A	40A	4	1	LS40 VZV A4U	1	0,58
55A	55A	4	1	LS55 VZV A4U	1	0,58

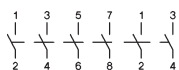

16A	10A	2	3	LS16 VZV A6	1	0,38
25A	11,5A	2	3	LS25 VZV A6	1	0,38
32A	13A	2	3	LS32 VZV A6	1	0,38
40A	29A	2	3	LS40 VZV A6	1	1,00
55A	36A	2	3	LS55 VZV A6	1	1,00

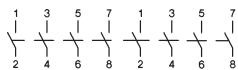

16A	10A	2	4	LS16 VZV A8	1	0,43
25A	11,5A	2	4	LS25 VZV A8	1	0,43
32A	13A	2	4	LS32 VZV A8	1	0,43
40A	29A	2	4	LS40 VZV A8	1	1,10
55A	36A	2	4	LS55 VZV A8	1	1,10

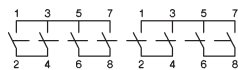

29A	29A	4	1	LS16 VZV A4+2	1	0,48
45A	45A	4	1	LS25 VZV A4+2	1	0,48
58A	58A	4	1	LS32 VZV A4+2	1	0,48
72A	72A	4	1	LS40 VZV A4+2	1	1,21
85A	85A	4	1	LS55 VZV A4+2	1	1,21

ON-OFF Switches for Distribution Boards, IP40, Open Type



DC21B / DC-PV1 600V DC	1000V DC	Poles in series	Number of Strings	Type	Pack pcs	Weight kg/pcs.
16A	10A	2	1	LS16 SMA A2	1	0,19
25A	11,5A	2	1	LS25 SMA A2	1	0,19
32A	13A	2	1	LS32 SMA A2	1	0,19
40A	29A	2	1	LS40 SMA A2	1	0,41
55A	36A	2	1	LS55 SMA A2	1	0,41

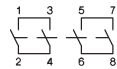

29A	10A	2	1	LS16 SMA A2+2	1	0,24
36A	11,5A	2	1	LS25 SMA A2+2	1	0,24
55A	13A	2	1	LS32 SMA A2+2	1	0,24
68A	29A	2	1	LS40 SMA A2+2	1	0,52
85A	36A	2	1	LS55 SMA A2+2	1	0,52

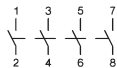

16A	10A	2	2	LS16 SMA A4	1	0,22
25A	11,5A	2	2	LS25 SMA A4	1	0,22
32A	13A	2	2	LS32 SMA A4	1	0,22
40A	29A	2	2	LS40 SMA A4	1	0,45
55A	36A	2	2	LS55 SMA A4	1	0,45

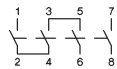

16A	16A	4	1	LS16 SMA A4B	1	0,23
25A	25A	4	1	LS25 SMA A4B	1	0,23
32A	32A	4	1	LS32 SMA A4B	1	0,23
40A	40A	4	1	LS40 SMA A4B	1	0,49
55A	55A	4	1	LS55 SMA A4B	1	0,49

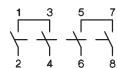

16A	16A	4	1	LS16 SMA A4O	1	0,23
25A	25A	4	1	LS25 SMA A4O	1	0,23
32A	32A	4	1	LS32 SMA A4O	1	0,23
40A	40A	4	1	LS40 SMA A4B	1	0,49
55A	55A	4	1	LS55 SMA A4B	1	0,49

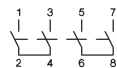

16A	16A	4	1	LS16 SMA A4U	1	0,23
25A	25A	4	1	LS25 SMA A4U	1	0,23
32A	32A	4	1	LS32 SMA A4U	1	0,23
40A	40A	4	1	LS40 SMA A4B	1	0,49
55A	55A	4	1	LS55 SMA A4B	1	0,49

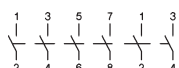

16A	10A	2	3	LS16 SMA A6	1	0,35
25A	11,5A	2	3	LS25 SMA A6	1	0,35
32A	13A	2	3	LS32 SMA A6	1	0,35
40A	29A	2	3	LS40 SMA A6	1	0,89
55A	36A	2	3	LS55 SMA A6	1	0,89

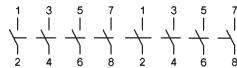

16A	10A	2	4	LS16 SMA A8	1	0,40
25A	11,5A	2	4	LS25 SMA A8	1	0,40
32A	13A	2	4	LS32 SMA A8	1	0,40
40A	29A	2	4	LS40 SMA A8	1	0,99
55A	36A	2	4	LS55 SMA A8	1	0,99

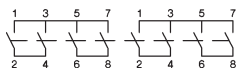

29A	29A	4	1	LS16 SMA A4+2	1	0,43
45A	45A	4	1	LS25 SMA A4+2	1	0,43
58A	58A	4	1	LS32 SMA A4+2	1	0,43
72A	72A	4	1	LS40 SMA A4+2	1	1,01
85A	85A	4	1	LS55 SMA A4+2	1	1,01

Main Switches for Panel Mounting, Escutcheon plate 64[□], IP66, US Type 4X



padlock device SV4



DC21B / DC-PV1 600V DC	DC 1000V DC	Poles in series	Number of Strings	Type	Pack pcs	Weight kg/pcs.
16A	10A	2	1	LS16 EH4 A2	1	0,21
25A	11,5A	2	1	LS25 EH4 A2	1	0,21
32A	13A	2	1	LS32 EH4 A2	1	0,21
40A	29A	2	1	LS40 EH4 A2	1	0,43
55A	36A	2	1	LS55 EH4 A2	1	0,43

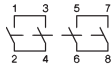

29A	10A	2	1	LS16 EH4 A2+2	1	0,26
36A	11,5A	2	1	LS25 EH4 A2+2	1	0,26
55A	13A	2	1	LS32 EH4 A2+2	1	0,26
68A	29A	2	1	LS40 EH4 A2+2	1	0,57
85A	36A	2	1	LS55 EH4 A2+2	1	0,57

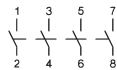

16A	16A	2	2	LS16 EH4 A4	1	0,24
25A	25A	2	2	LS25 EH4 A4	1	0,24
32A	32A	2	2	LS32 EH4 A4	1	0,24
40A	40A	2	2	LS40 EH4 A4	1	0,50
55A	55A	2	2	LS55 EH4 A4	1	0,50

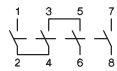

16A	10A	4	1	LS16 EH4 A4B	1	0,25
25A	11,5A	4	1	LS25 EH4 A4B	1	0,25
32A	13A	4	1	LS32 EH4 A4B	1	0,25
40A	29A	4	1	LS40 EH4 A4B	1	0,53
55A	36A	4	1	LS55 EH4 A4B	1	0,53

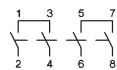

16A	16A	4	1	LS16 EH4 A4O	1	0,25
25A	25A	4	1	LS25 EH4 A4O	1	0,25
32A	32A	4	1	LS32 EH4 A4O	1	0,25
40A	40A	4	1	LS40 EH4 A4O	1	0,53
55A	55A	4	1	LS55 EH4 A4O	1	0,53

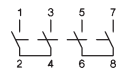

16A	16A	4	1	LS16 EH4 A4U	1	0,25
25A	25A	4	1	LS25 EH4 A4U	1	0,25
32A	32A	4	1	LS32 EH4 A4U	1	0,25
40A	40A	4	1	LS40 EH4 A4U	1	0,53
55A	55A	4	1	LS55 EH4 A4U	1	0,53

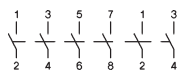

16A	10A	2	3	LS16 EH4 A6	1	0,37
25A	11,5A	2	3	LS25 EH4 A6	1	0,37
32A	13A	2	3	LS32 EH4 A6	1	0,37
40A	29A	2	3	LS40 EH4 A6	1	0,53
55A	36A	2	3	LS55 EH4 A6	1	0,53

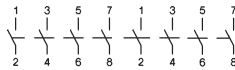

16A	10A	2	4	LS16 EH4 A8	1	0,42
25A	11,5A	2	4	LS25 EH4 A8	1	0,42
32A	13A	2	4	LS32 EH4 A8	1	0,42
40A	29A	2	4	LS40 EH4 A8	1	1,10
55A	36A	2	4	LS55 EH4 A8	1	1,10

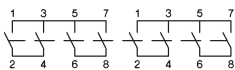

29A	29A	4	1	LS16 EH4 A4+2	1	0,47
45A	45A	4	1	LS25 EH4 A4+2	1	0,47
58A	58A	4	1	LS32 EH4 A4+2	1	0,47
72A	72A	4	1	LS40 EH4 A4+2	1	1,21
85A	85A	4	1	LS55 EH4 A4+2	1	1,21

Extended Switch Shaft for all switches for panel mounting

type suffix

+VW“x“

x = panel thickness

Main Switches for Single Hole Mounting Ø22mm, Escutcheon plate 48³, IP66, c us Type 4X



padlock device SV1



DC21B / DC-PV1 600V DC	DC 1000V DC	Poles in series	Number of Strings	Type	Pack pcs	Weight kg/pcs.
16A	10A	2	1	LS16 ZH1 A2	1	0,21
25A	11,5A	2	1	LS25 ZH1 A2	1	0,21
32A	13A	2	1	LS32 ZH1 A2	1	0,21

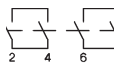

29A	10A	2	1	LS16 ZH1 A2+2	1	0,27
36A	11,5A	2	1	LS25 ZH1 A2+2	1	0,27
55A	13A	2	1	LS32 ZH1 A2+2	1	0,27

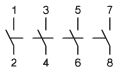

16A	10A	2	2	LS16 ZH1 A4	1	0,24
25A	11,5A	2	2	LS25 ZH1 A4	1	0,24
32A	13A	2	2	LS32 ZH1 A4	1	0,24

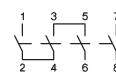

16A	16A	4	1	LS16 ZH1 A4B	1	0,25
25A	25A	4	1	LS25 ZH1 A4B	1	0,25
32A	32A	4	1	LS32 ZH1 A4B	1	0,25

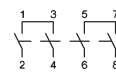

16A	16A	4	1	LS16 ZH1 A4O	1	0,25
25A	25A	4	1	LS25 ZH1 A4O	1	0,25
32A	32A	4	1	LS32 ZH1 A4O	1	0,25

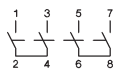

16A	16A	4	1	LS16 ZH1 A4U	1	0,25
25A	25A	4	1	LS25 ZH1 A4U	1	0,25
32A	32A	4	1	LS32 ZH1 A4U	1	0,25

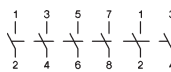

16A	10A	2	3	LS16 ZH1 A6	1	0,39
25A	11,5A	2	3	LS25 ZH1 A6	1	0,39
32A	13A	2	3	LS32 ZH1 A6	1	0,39

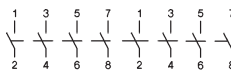

16A	10A	2	4	LS16 ZH1 A8	1	0,44
25A	11,5A	2	4	LS25 ZH1 A8	1	0,44
32A	13A	2	4	LS32 ZH1 A8	1	0,44

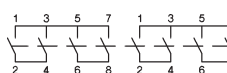

29A	29A	4	1	LS16 ZH1 A4+2	1	0,49
45A	45A	4	1	LS25 ZH1 A4+2	1	0,49
58A	58A	4	1	LS32 ZH1 A4+2	1	0,49

Main Switches f. Base Mounting, Door Clutch f. Single Hole, Escutcheon plate 64[□], IP66,



DC21B / DC-PV1 600V DC 1000V DC	Poles in series	Number of Strings	Type	Pack pcs	Weight kg/pcs.
16A 10A	2	1	LS16 VZVH4 A2	1	0,23
25A 11,5A	2	1	LS25 VZVH4 A2	1	0,23
32A 13A	2	1	LS32 VZVH4 A2	1	0,23
40A 29A	2	1	LS40 VZVH4 A2	1	0,51
55A 36A	2	1	LS55 VZVH4 A2	1	0,51

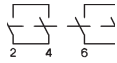

29A 10A	2	1	LS16 VZVH4 A2+2	1	0,28
36A 11,5A	2	1	LS25 VZVH4 A2+2	1	0,28
55A 13A	2	1	LS32 VZVH4 A2+2	1	0,28
68A 29A	2	1	LS40 VZVH4 A2+2	1	0,65
85A 36A	2	1	LS55 VZVH4 A2+2	1	0,65

Depth is adjustable
see page 317
padlock device SV4

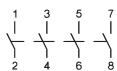

16A 10A	2	2	LS16 VZVH4 A4	1	0,26
25A 11,5A	2	2	LS25 VZVH4 A4	1	0,26
32A 13A	2	2	LS32 VZVH4 A4	1	0,26
40A 29A	2	2	LS40 VZVH4 A4	1	0,58
55A 36A	2	2	LS55 VZVH4 A4	1	0,58

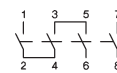

16A 16A	4	1	LS16 VZVH4 A4B	1	0,27
25A 25A	4	1	LS25 VZVH4 A4B	1	0,27
32A 32A	4	1	LS32 VZVH4 A4B	1	0,27
40A 40A	4	1	LS40 VZVH4 A4B	1	0,62
55A 55A	4	1	LS55 VZVH4 A4B	1	0,62

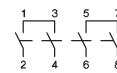

16A 16A	4	1	LS16 VZVH4 A4O	1	0,27
25A 25A	4	1	LS25 VZVH4 A4O	1	0,27
32A 32A	4	1	LS32 VZVH4 A4O	1	0,27
40A 40A	4	1	LS40 VZVH4 A4O	1	0,62
55A 55A	4	1	LS55 VZVH4 A4O	1	0,62

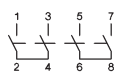

16A 16A	4	1	LS16 VZVH4 A4U	1	0,27
25A 25A	4	1	LS25 VZVH4 A4U	1	0,27
32A 32A	4	1	LS32 VZVH4 A4U	1	0,27
40A 40A	4	1	LS40 VZVH4 A4U	1	0,62
55A 55A	4	1	LS55 VZVH4 A4U	1	0,62

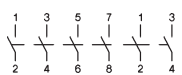

16A 10A	2	3	LS16 VZVH4 A6	1	0,39
25A 11,5A	2	3	LS25 VZVH4 A6	1	0,39
32A 13A	2	3	LS32 VZVH4 A6	1	0,39
40A 29A	2	3	LS40 VZVH4 A6	1	1,00
55A 36A	2	3	LS55 VZVH4 A6	1	1,00

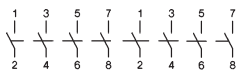



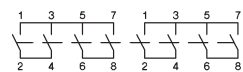





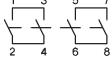

16A 10A	2	4	LS16 VZVH4 A8	1	0,44
25A 11,5A	2	4	LS25 VZVH4 A8	1	0,44
32A 13A	2	4	LS32 VZVH4 A8	1	0,44
40A 29A	2	4	LS40 VZVH4 A8	1	1,11
55A 36A	2	4	LS55 VZVH4 A8	1	1,11

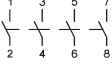

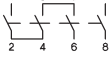
29A 29A	4	1	LS16 VZVH4 A4+2	1	0,49
45A 45A	4	1	LS25 VZVH4 A4+2	1	0,49
58A 58A	4	1	LS32 VZVH4 A4+2	1	0,49
72A 72A	4	1	LS40 VZVH4 A4+2	1	1,22
85A 85A	4	1	LS55 VZVH4 A4+2	1	1,22

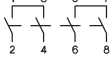
Main Switches for Distribution Boards, IP40, Open Type

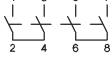
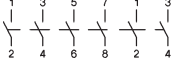
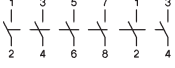
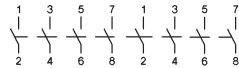
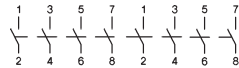
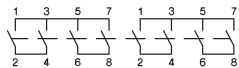
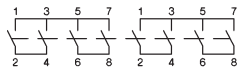
	DC21B / DC-PV1 600V DC	1000V DC	Poles in series	Number of Strings	Type	Pack pcs	Weight kg/pcs.		
			16A	10A	2	1	LS16 SMAH1 A2	1	0,19
			25A	11,5A	2	1	LS25 SMAH1 A2	1	0,19
			32A	13A	2	1	LS32 SMAH1 A2	1	0,19
			40A	29A	2	1	LS40 SMAH1 A2	1	0,40
			55A	36A	2	1	LS55 SMAH1 A2	1	0,40
padlock device SV1 			29A	10A	2	1	LS16 SMAH1 A2+2 ¹⁾	1	0,25
			36A	11,5A	2	1	LS25 SMAH1 A2+2 ¹⁾	1	0,25
			55A	13A	2	1	LS32 SMAH1 A2+2 ¹⁾	1	0,25
			68A	29A	2	1	LS40 SMAH1 A2+2	1	0,54
			85A	36A	2	1	LS55 SMAH1 A2+2	1	0,54
			16A	10A	2	2	LS16 SMAH1 A4 ¹⁾	1	0,22
			25A	11,5A	2	2	LS25 SMAH1 A4 ¹⁾	1	0,22
			32A	13A	2	2	LS32 SMAH1 A4 ¹⁾	1	0,22
			40A	29A	2	2	LS40 SMAH1 A4	1	0,47
			55A	36A	2	2	LS55 SMAH1 A4	1	0,47
			16A	16A	4	1	LS16 SMAH1 A4B ¹⁾	1	0,23
			25A	25A	4	1	LS25 SMAH1 A4B ¹⁾	1	0,23
			32A	32A	4	1	LS32 SMAH1 A4B ¹⁾	1	0,23
			40A	40A	4	1	LS40 SMAH1 A4B	1	0,50
			55A	55A	4	1	LS55 SMAH1 A4B	1	0,50
			16A	16A	4	1	LS16 SMAH1 A4O ¹⁾	1	0,23
			25A	25A	4	1	LS25 SMAH1 A4O ¹⁾	1	0,23
			32A	32A	4	1	LS32 SMAH1 A4O ¹⁾	1	0,23
			40A	40A	4	1	LS40 SMAH1 A4B	1	0,50
			55A	55A	4	1	LS55 SMAH1 A4B	1	0,50
			16A	16A	4	1	LS16 SMAH1 A4U ¹⁾	1	0,23
			25A	25A	4	1	LS25 SMAH1 A4U ¹⁾	1	0,23
			32A	32A	4	1	LS32 SMAH1 A4U ¹⁾	1	0,23
			40A	40A	4	1	LS40 SMAH1 A4B	1	0,50
			55A	55A	4	1	LS55 SMAH1 A4B	1	0,50
			16A	10A	2	3	LS16 SMAH1 A6	1	0,36
			25A	11,5A	2	3	LS25 SMAH1 A6	1	0,36
			32A	13A	2	3	LS32 SMAH1 A6	1	0,36
			40A	29A	2	3	LS40 SMAH1 A6	1	0,90
			55A	36A	2	3	LS55 SMAH1 A6	1	0,90
			16A	10A	2	4	LS16 SMAH1 A8	1	0,41
			25A	11,5A	2	4	LS25 SMAH1 A8	1	0,41
			32A	13A	2	4	LS32 SMAH1 A8	1	0,41
			40A	29A	2	4	LS32 SMAH1 A8	1	0,41
			55A	36A	2	4	LS32 SMAH1 A8	1	0,41
			29A	29A	4	1	LS16 SMAH1 A4+2	1	0,46
			45A	45A	4	1	LS25 SMAH1 A4+2	1	0,46
			58A	58A	4	1	LS32 SMAH1 A4+2	1	0,46
			72A	72A	4	1	LS40 SMAH1 A4+2	1	1,12
			85A	85A	4	1	LS55 SMAH1 A4+2	1	1,12

¹⁾ Main Switches for Distribution Boards with low height handle, IP40,   Open Type

Type with Type-suffix „+SV1N“ e.g. **LS.. SMAH1 A2+2 +SV1N**

Main Switches in Plastic Enclosure, Escutcheon plate 64[□], IP66, Type 4X



padlock device SV4



DC21B / DC-PV1 600V DC	1000V DC	Poles in series	Number of Strings	Type	Pack pcs	Weight kg/pcs.
16A	10A	2	1	LS16 PFLH4 A2 ¹⁾	1	0,43
25A	11,5A	2	1	LS25 PFLH4 A2 ¹⁾	1	0,43
32A	13A	2	1	LS32 PFLH4 A2 ¹⁾	1	0,43
40A	29A	2	1	LS40 PFLH4 A2	1	1,59
55A	36A	2	1	LS55 PFLH4 A2	1	1,59

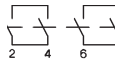

29A	10A	2	1	LS16 PFLH4 A2+2 ¹⁾	1	0,49
36A	11,5A	2	1	LS25 PFLH4 A2+2 ¹⁾	1	0,49
55A	13A	2	1	LS32 PFLH4 A2+2 ¹⁾	1	0,49
68A	29A	2	1	LS40 PFLH4 A2+2	1	1,74
85A	36A	2	1	LS55 PFLH4 A2+2	1	1,74

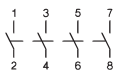

16A	10A	2	2	LS16 PFLH4 A4 ¹⁾	1	0,46
25A	11,5A	2	2	LS25 PFLH4 A4 ¹⁾	1	0,46
32A	13A	2	2	LS32 PFLH4 A4 ¹⁾	1	0,46
40A	29A	2	2	LS40 PFLH4 A4	1	1,67
55A	36A	2	2	LS55 PFLH4 A4	1	1,67

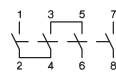

16A	16A	4	1	LS16 PFLH4 A4B ¹⁾	1	0,47
25A	25A	4	1	LS25 PFLH4 A4B ¹⁾	1	0,47
32A	32A	4	1	LS32 PFLH4 A4B ¹⁾	1	0,47
40A	40A	4	1	LS40 PFLH4 A4B	1	1,70
55A	55A	4	1	LS55 PFLH4 A4B	1	1,70

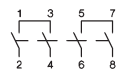

16A	16A	4	1	LS16 PFLH4 A4O ¹⁾	1	0,47
25A	25A	4	1	LS25 PFLH4 A4O ¹⁾	1	0,47
32A	32A	4	1	LS32 PFLH4 A4O ¹⁾	1	0,47
40A	40A	4	1	LS40 PFLH4 A4O	1	1,70
55A	55A	4	1	LS55 PFLH4 A4O	1	1,70

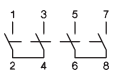

16A	16A	4	1	LS16 PFLH4 A4U ¹⁾	1	0,47
25A	25A	4	1	LS25 PFLH4 A4U ¹⁾	1	0,47
32A	32A	4	1	LS32 PFLH4 A4U ¹⁾	1	0,47
40A	40A	4	1	LS40 PFLH4 A4U	1	1,70
55A	55A	4	1	LS55 PFLH4 A4U	1	1,70

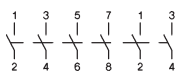

16A	10A	2	3	LS16 PFLH4 A6	1	1,53
25A	11,5A	2	3	LS25 PFLH4 A6	1	1,53
32A	13A	2	3	LS32 PFLH4 A6	1	1,53
40A	29A	2	3	LS40 PFLH4 A6	1	1,87
55A	36A	2	3	LS55 PFLH4 A6	1	1,87

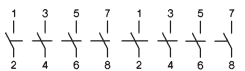

16A	10A	2	4	LS16 PFLH4 A8	1	1,58
25A	11,5A	2	4	LS25 PFLH4 A8	1	1,58
32A	13A	2	4	LS32 PFLH4 A8	1	1,58
40A	29A	2	4	LS40 PFLH4 A8	1	1,94
55A	36A	2	4	LS55 PFLH4 A8	1	1,94

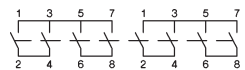

29A	29A	4	1	LS16 PFLH4 A4+2	1	1,63
45A	45A	4	1	LS25 PFLH4 A4+2	1	1,63
58A	58A	4	1	LS32 PFLH4 A4+2	1	1,63
72A	72A	4	1	LS40 PFLH4 A4+2	1	2,07
85A	85A	4	1	LS55 PFLH4 A4+2	1	2,07

Technical Data

Kind of current	Category		Typical applications	Test conditions for the number of on-load operating cycles (normal service)						Test conditions for making and breaking capacities (operation in fault case)					
				Make		Break		Make		Break					
				I/le	U _r /U _e	L/R	I _c /I _e	U _r /U _e	L/R	I/le	U _r /U _e	L/R	I _c /I _e	U _r /U _e	L/R
Direct current	DC21A frequent operation	DC21B infrequent operation	Switching of resistive loads including moderate overloads	1	1	1ms	1	1	1ms	1,5	1,05	1ms	1,5	1,05	1ms
	DC22A frequent operation	DC22B infrequent operation	Switching of mixed resistive a.induct. loads incl. moderate overloads (shunt motors)	1	1	2ms	1	1	2ms	4	1,05	2,5ms	4	1,05	2,5ms
	DC-PV1		Switching of single PV string(s) without reverse- and overcurrents.	1	1	1ms	1	1	1ms	1,5	1,05	1ms	1,5	1,05	1ms
	DC-PV2		Switching of several PV strings with reverse- and overcurrents.	1	1	1ms	1	1	1ms	4	1,05	1ms	4	1,05	1ms





Data according to IEC 60947-3, VDE 0660, GB14048.3 (CCC China)

Main contacts			Type	LS16	LS25	LS32	LS40	LS55
Rated thermal current I _{the}			A	16	25	32	40	55
Rated insulation voltage U _i ¹⁾			V	1000	1000	1000	1500	1500
Rated insulation voltage U _i ²⁾			V	1500	1500	1500	1500	1500
Distance of contacts (per pole)			mm	8	8	8		
Rated operational current I_e								
DC21A and DC21B	1 pole	300V	A	16	23	27	40	55
		400V	A	12	14	16	30	40
	A1	500V	A	9	11	13	19	25
		600V	A	6	8	10	15	20
DC21B	1 pole	700V	A	4,5	6	7,5	10	15
		800V	A	3	4	5	8	10
	A2	900V	A	2,5	3	4	6	8
		1000V	A	1,5	2	2,5	4	6
	2 pole in series	500V	A	16	25	32	40	55
		600V	A	16	25	32	40	55
	A2	700V	A	16	23	27	35	55
		800V	A	16	20	21	30	45
	A2+2	900V	A	13	16	18	25	35
		1000V	A	9	11	13	20	36
A2+2	1200V	A	6	8	10	10	15	
	1500V	A	3	4	5	6	7,5	
3 poles in series + 2 poles parallel	500V	A	29	45	58	72	85	
	600V	A	29	45	50	64	80	
A3+2	700V	A	16	23	27	35	55	
	800V	A	16	20	21	30	45	
A3+2	900V	A	13	16	18	25	35	
	1000V	A	9	11	13	20	25	
A3+2	1200V	A	6	8	10	10	15	
	1500V	A	3	4	5	6	7,5	
4 poles in series	500V	A	16	25	32	40	55	
	600V	A	16	25	32	40	55	
A4	700V	A	16	25	32	40	55	
	800V	A	16	25	32	40	55	
A4	900V	A	16	25	32	40	55	
	1000V	A	16	25	32	40	55	
A4	1200V	A	16	25	32	40	55	
	1500V	A	16	20	23	30	40	
4 poles in series + 2 poles parallel	500V	A	29	45	58	72	85	
	600V	A	29	45	58	72	85	
A4+2	700V	A	29	45	58	72	85	
	800V	A	29	45	58	72	85	
A4+2	900V	A	29	45	58	72	85	
	1000V	A	29	45	58	72	85	
A4+2	1200V	A	29	45	50	56	65	
	1500V	A	16	20	23	42	55	
Rated operational current I_e								
AC21B	A2, A4	U _e max. 440V	A	16	25	32	40	55
	A2+2	U _e max. 440V	A	29	45	58	72	85

1) Suitable at overvoltage category I to III, pollution degree 3 (standard-industry): U_{imp} = 8kV.
 2) Suitable at overvoltage category I to III, pollution degree 2 (min. IP55): U_{imp} = 8kV.

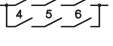

Technical Data

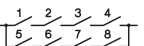
Data according to IEC 60947-3, VDE 0660

Main contacts		Type	LS16	LS25	LS32	LS40	LS55	
Rated operational current I_e DC-PV1	300V	A	16	23	27	40	55	
	400V	A	14	22	25	33	44	
1 pole A1 	500V	A	10	17	20	24	32	
	600V	A	7	12	15	19	25	
	700V	A	5	6	7	12	18	
	800V	A	3	4	5	10	13	
	900V	A	3	3	4	8	10	
	1000V	A	2	2	3	5	8	
	2 poles in series A2 	500V	A	16	25	32	40	55
600V		A	16	25	32	40	55	
700V		A	16	25	32	37	55	
800V		A	16	19	21	35	55	
900V		A	16	17	18	31	43	
1000V		A	10	11,5	13	29	36	
1100V		A	8	10	11,5	19	25	
1200V		A	7	8,5	10	11	17	
1300V		A	6	7	8	10	14	
1400V		A	5	6	7	9	12	
1500V		A	3	5	6	7,5	10	
2 poles in series + 2 poles parallel A2+2 		500V	A	29	45	58	72	85
		600V	A	29	36	55	68	85
	700V	A	22	27	32	49	77	
	800V	A	17	19	21	42	63	
	900V	A	16	17	18	31	43	
	1000V	A	10	11,5	13	29	36	
	1100V	A	8	10	11,5	19	25	
	1200V	A	7	8,5	10	11	17	
	1300V	A	6	7	8	10	14	
	1400V	A	5	6	7	9	12	
	1500V	A	3	5	6	7,5	10	
	3 poles in series + 2 poles parallel A3+2 	500V	A	29	45	58	72	85
		600V	A	29	45	58	72	85
700V		A	29	43	55	72	85	
800V		A	29	40	51	68	85	
900V		A	29	38	47	62	78	
1000V		A	29	38	45	58	70	
1100V		A	19	27	37	-	-	
1200V		A	17	25	28	-	-	
1300V		A	15	21	25	-	-	
1400V		A	12	18	22	-	-	
1500V		A	10	14	20	-	-	
4 poles in series A4 		500V	A	16	25	32	40	55
		600V	A	16	25	32	40	55
	700V	A	16	25	32	40	55	
	800V	A	16	25	32	40	55	
	900V	A	16	25	32	40	55	
	1000V	A	16	25	32	40	55	
	1100V	A	16	25	32	40	55	
	1200V	A	16	25	32	40	55	
	1300V	A	16	25	32	40	55	
	1400V	A	16	25	32	40	55	
	1500V	A	16	25	32	40	55	
	4 poles in series + 2 poles parallel A4+2 	500V	A	29	45	58	72	85
		600V	A	29	45	58	72	85
700V		A	29	45	58	72	85	
800V		A	29	45	58	72	85	
900V		A	29	45	58	72	85	
1000V		A	29	45	58	72	85	
1100V		A	29	45	54	60	68	
1200V		A	29	45	50	56	65	
1300V		A	26	39	44	50	61	
1400V		A	23	33	38	46	58	
1500V		A	20	26	32	42	55	

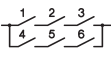
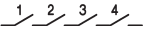
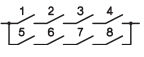

Technical Data

Data according to IEC 60947-3, VDE 0660

Main contacts		Type	LS16	LS25	LS32	LS40	LS55	
Rated operational current I_e DC-PV2	300V	A	16	23	27	40	55	
	400V	A	15	18	20	30	40	
1 pole A1 	500V	A	10	12	14	19	25	
	600V	A	5	6	8	10	13	
	700V	A	1,5	2	3	7	10	
	800V	A	1,5	2	3	6	8	
	900V	A	1	1,5	2,0	5	6	
	1000V	A	1	1,5	2,0	3	4	
	2 poles in series A2 	500V	A	16	25	32	40	55
		600V	A	14	21	27	40	55
		700V	A	13	19	22	35	55
		800V	A	12	15	17	33	49
900V		A	8	10	12	25	35	
1000V		A	4	5	6	16	20	
1100V		A	3	4	5	11	15	
1200V		A	2	3	4	8	12	
1300V		A	1,5	2	3	7	10	
1400V		A	1	2	3	7	9	
1500V	A	1	1,5	2	6	8		
2 poles in series + 2 poles parallel A2+2 	500V	A	25	39	50	72	85	
	600V	A	20	32	35	60	75	
	700V	A	13	19	22	38	60	
	800V	A	12	15	17	33	49	
	900V	A	8	10	12	25	35	
	1000V	A	4	5	6	16	25	
	1100V	A	3	4	5	10	15	
	1200V	A	2	3	4	8	12	
	1300V	A	1,5	2	3	7	10	
	1400V	A	1	2	3	7	9	
1500V	A	1	1,5	2	6	8		
3 poles in series + 2 poles parallel A3+2 	500V	A	-	-	-	72	85	
	600V	A	-	-	-	72	78	
	700V	A	-	-	-	62	69	
	800V	A	-	-	-	53	61	
	900V	A	-	-	-	44	55	
	1000V	A	-	-	-	35	50	
	1100V	A	-	-	-	-	-	
	1200V	A	-	-	-	-	-	
	1300V	A	-	-	-	-	-	
	1400V	A	-	-	-	-	-	
1500V	A	-	-	-	-	-		
4 poles in series A4 	500V	A	16	25	32	40	55	
	600V	A	16	25	32	40	55	
	700V	A	16	25	32	40	55	
	800V	A	16	25	32	40	55	
	900V	A	16	25	32	40	55	
	1000V	A	16	25	32	40	55	
	1100V	A	16	25	32	40	55	
	1200V	A	13,5	21	27	40	55	
	1300V	A	12	19	24	36	50	
	1400V	A	10,5	16	21	33	45	
1500V	A	9	14	18	30	40		
4 poles in series + 2 poles parallel A4+2 	500V	A	-	-	-	72	85	
	600V	A	-	-	-	72	85	
	700V	A	-	-	-	72	80	
	800V	A	-	-	-	67	75	
	900V	A	-	-	-	59	70	
	1000V	A	-	-	-	52	64	
	1100V	A	-	-	-	44	59	
	1200V	A	-	-	-	40	55	
	1300V	A	-	-	-	36	50	
	1400V	A	-	-	-	33	45	
1500V	A	-	-	-	30	40		

Technical Data







Data according to IEC 60947-3, VDE 0660

Main contacts		Type	LS16	LS25	LS32	LS40	LS55
Rated operational current I_e DC22B	1 pole	A	1	1,25	1,5	x	2,5
	A1	A	0,5	0,75	1	x	2,0
		A	0,3	0,4	0,5	x	1,5
	2 poles in series	A	0,15	0,2	0,25	x	1,0
	A2	A	-	-	-	x	x
		A	-	-	-	x	x
	4 poles in series	A	7	8	9	x	x
	A4	A	5,5	6	6,5	x	x
		A	2	2,5	3	x	x
	1000V	A	1	1,5	2	x	x
	1200V	A	-	-	-	x	x
	1500V	A	-	-	-	x	x
	1000V	A	16	25	32	x	x
	1200V	A	16	25	27,5	x	x
	1500V	A	11,5	12	12,5	x	x
	1000V	A	8	9	10	x	x
	1200V	A	-	-	-	x	x
	1500V	A	-	-	-	x	x
Rated conditional short-circuit current		kA _{eff}	5	5	5	10	10
Max. fuse size		gL (gG)	40	63	80	125	160
Mechanical life		x10 ³	10	10	10	10	10
Rated short-time withstand current (1s)	lcw	A2, A4, A6, A8	800	900	1000	A2, A4: 1200	A2, A4: 1400
		A2+2, A3+2, A4+2	1300	1500	1700	A2+2: 2000	A2+2: 2400
Short circuit making capacity	lcm	A2, A4, A6, A8	800	900	1000	A2, A4: 1200	A2, A4: 1400
		A2+2, A3+2, A4+2	1300	1500	1700	A2+2: 2000	A2+2: 2400
Maximum cable cross sections (incl. jumper LSV-B1)							
solid or stranded		mm ²	4 - 16	4 - 16	4 - 16	2,5 - 25	2,5 - 25
flexible		mm ²	4 - 10	4 - 10	4 - 10	4 - 16	4 - 16
flexible (+ multicore cable end)		mm ²	4 - 10	4 - 10	4 - 10	2,5 - 16	2,5 - 16
Size of terminal screw			M4 Pz2	M4 Pz2	M4 Pz2	M5 Pz2	M5 Pz2
Tightening torque		Nm	1,7 - 1,8	1,7 - 1,8	1,7 - 1,8	2,5 - 2,8	2,5 - 2,8
2 cables per clamp without jumper LSV-B1 / LSV-B2							
solid or stranded		mm ²	16+(1,5-2,5) / 10+(1,5-6) / 6+(1,5-10) / 4+(1,5-10)			16+(1,5-2,5) / 10+(1,5-10) / 6+(1,5-10) / 4+(1,5-10)	
flexible & flexible + multicore cable end		mm ²	16+(1,5-2,5) / 10+(1,5-4) / 6+(1,5-6)			16+(1,5-6) / 10+(1,5-10) / 6+(1,5-16) / 4+(1,5-16)	
stranded		AWG	8+(16-12) / 10+(16-10) / 12+(16-8) 14+(16-8)			3+(18-10) / 4+(18-10) / 6+(18-8) 8+(18-8)	
solid		AWG	10+(16-12) / 12+(16-10) 14+(16-10)			10+(16-10) / 12+(16-10) / 14+(16-10) 12+(16-10) / 14+(16-10)	
Maximum ambient temperature							
Operation	open	°C	-40 to +65				
	enclosed	°C	-40 to +45				
Storage		°C	-50 to +90				
Power loss per switch at I _e max.			A	A	A	A	A
A2	(A)/ W	(16)/ 1	(25)/ 2,3	(32)/ 3,7	(40)/ 4	(55)/ 7,5	
A4	(A)/ W	(16)/ 2	(25)/ 4,6	(32)/ 7,4	(40)/ 8	(55)/ 15	
A6	(A)/ W	(16)/ 3	(25)/ 6,9	(32)/ 11,1	(40)/ 12	(55)/ 22,5	
A8	(A)/ W	(16)/ 4	(25)/ 9,2	(32)/ 14,8	(40)/ 16	(55)/ 30	
A2+2	(A)/ W	(29)/ 1,5	(45)/ 3,7	(58)/ 6	(72)/ 6,5	(85)/ 9	
A3+2	(A)/ W	(29)/ 2,3	(45)/ 5,6	(58)/ 9	(72)/ 9,8	(85)/ 14	
A4+2	(A)/ W	(29)/ 3	(45)/ 7,4	(58)/ 12	(72)/ 13	(85)/ 18	
Contact resistance per pole		mΩ	1,75	1,75	1,75	1,25	1,25

x in test

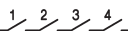
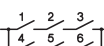
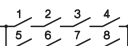





Technical Data

Data according to UL508I  File E359344, Category no.: NMSJ, and UL508 c  File E332938, Category no.: NRNT2, NRNT8

Type			LS16	LS25	LS32	LS40	LS55	
Ampere-Rating "General use" 1 Pol 	DC							
	350V	A	4	5	6	7,1	10,0	
	500V	A	4	5	6	5,7	7,0	
	600V	A	4	5	6	5,0	5,8	
	700V	A	-	-	-	3,9	5,0	
	800V	A	-	-	-	3,2	4,4	
	900V	A	-	-	-	2,5	3,5	
	1000V	A	-	-	-	1,5	2,0	
	2 poles in series A2 	350V	A	16	25	32	40	55
		500V	A	16	25	32	40	55
600V		A	16	25	32	40	55	
700V		A	-	-	-	32	46	
800V		A	-	-	-	26	37	
900V		A	-	-	-	20	28	
1000V		A	-	-	-	16	20	
2 poles in series + 2 poles parallel A2+2 		350V	A	29	45	58	72	85
		400V	A	-	-	-	67	79
		500V	A	29	38	40	53	66
	600V	A	21	27	32	42	55	
	700V	A	-	-	-	35	47	
	800V	A	-	-	-	30	40	
	900V	A	-	-	-	26	32	
	1000V	A	-	-	-	22	25	
	4 poles in series A4 	350V	A	16	25	32	40	55
		500V	A	16	25	32	40	55
600V		A	16	25	32	40	55	
700V		A	-	-	-	40	55	
800V		A	-	-	-	40	55	
900V		A	-	-	-	40	55	
1000V		A	-	-	-	40	55	
3 poles in series + 2 poles parallel A3+2 		350V	A	29	45	58	68	71
		500V	A	29	38	50	56	64
		600V	A	21	38	45	52	60
	700V	A	-	-	-	46	57	
	800V	A	-	-	-	40	55	
	900V	A	-	-	-	36	53	
	1000V	A	-	-	-	33	51	
	4 poles in series + 2 poles parallel A4+2 	350V	A	29	45	58	80	85
		500V	A	29	45	58	71	85
		600V	A	29	45	50	65	82
700V		A	-	-	-	58	76	
800V		A	-	-	-	51	71	
900V		A	-	-	-	45	67	
1000V		A	-	-	-	42	64	
AC-Rating "General use" 2 poles in series 		600V	A	16	25	32	40	55
		277V	A	-	-	50	72	85
		+ 2 poles parallel 						
3 poles parallel 	3x480V	A	-	-	32	-	-	
Fuse size (RK5) Industrial Control Switch 5kA / 600V		A	40	60	80	-	-	
	5KA/1000V	A	-	-	-	160	160	
Maximum cable cross sections (incl. jumper LSV-B1)								
solid or stranded	AWG		12 - 10	12 - 10	12 - 10	16 - 10	16 - 10	
flexible	AWG		12 - 6	12 - 6	12 - 6	14 - 4	14 - 4	
flexible (+ multicore cable end)	AWG		12 - 6	12 - 6	12 - 6			
Size of terminal screw			M4 Pz2	M4 Pz2	M4 Pz2	M5 Pz2	M5 Pz2	
Tightening torque	lb.inch		9 - 16	9 - 16	9 - 16	22 - 25	22 - 25	
Protection class of terminals ¹⁾			IP20	IP20	IP20	IP20	IP20	

1) Protection degree of the terminals with connected insulated conductor.

Approvals

Country	USA, UL508I	US, Canada UL508	Europe	TÜVRheinland	China CCC	CB-Zertifikate	EAC
Type							
LS16	o	o	/	o	o	o	o
LS25	o	o	/	o	o	o	o
LS32	o	o	/	o	o	o	o
LS40	o	o	/	-	-	o	o
LS55	o	o	/	-	-	o	o

o In standard version approved

/ No testing required CE

x In test

- Not provided for test till now

Technical Datas

Maximum current according to ambient temperature and cable cross section

Switch open LS16..., 2 contacts in series (A2)

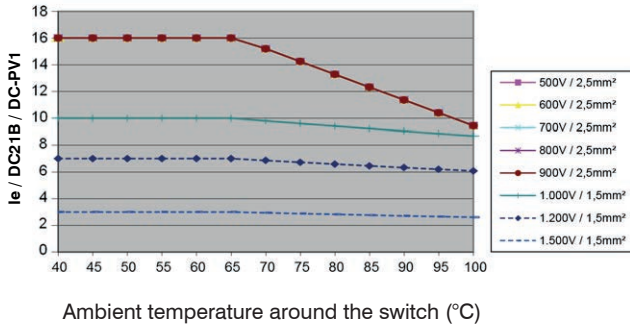

Switch open LS16 ..., 2 contacts in series + 2 parallel (A2+2)

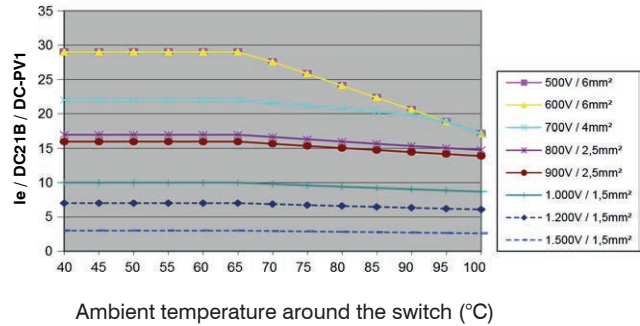

Switch open LS16..., 4 contacts in series (A4x)

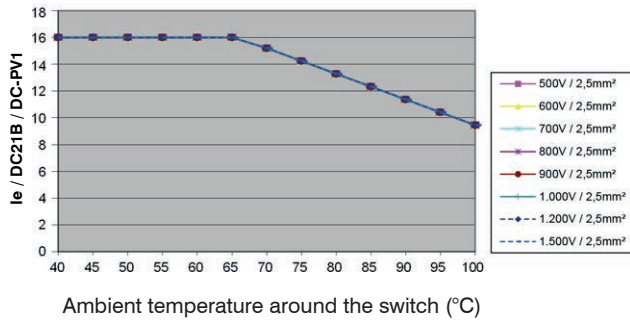

Switch open LS16 ..., 4 contacts in series + 2 parallel (A4+2)

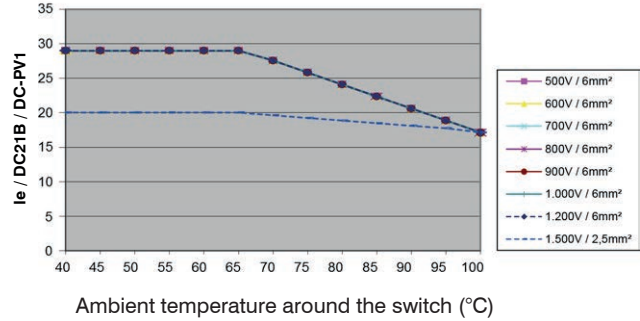

Switch enclosed LS16 PFL..., 2 contacts in series (A2)

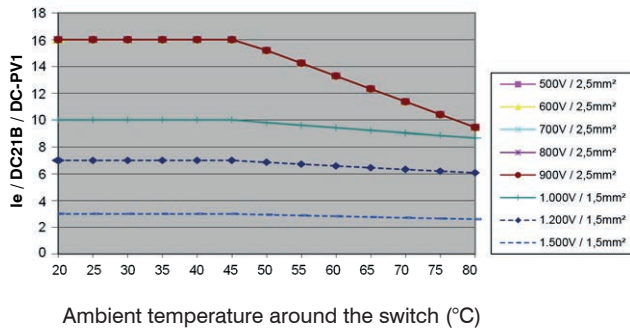

Switch enclosed LS16 PFL..., 2 contacts in series + 2 parallel (A2+2)

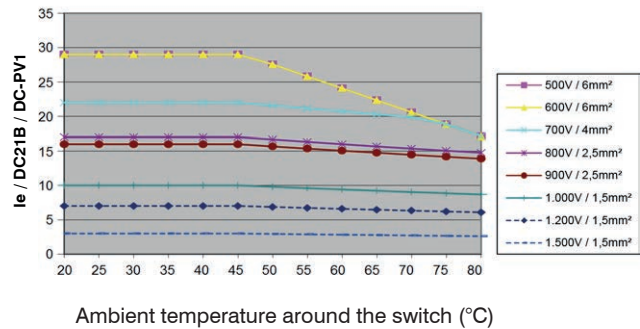

Switch enclosed LS16 PFL..., 4 contacts in series (A4x)

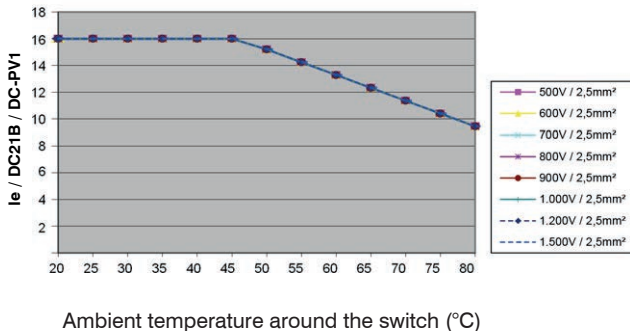

Switch enclosed LS16 PFL..., 4 contacts in series + 2 parallel (A4+2)

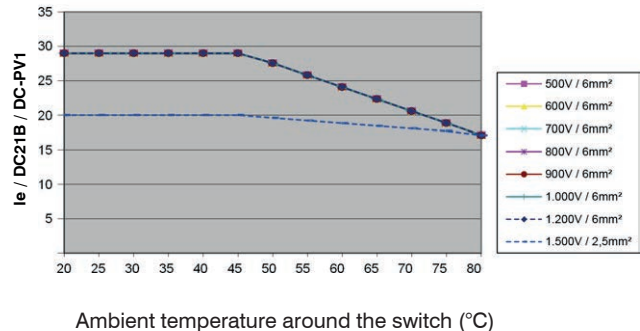

Technical Datas

Maximum current according to ambient temperature and cable cross section

Switch open LS25..., 2 contacts in series (A2)

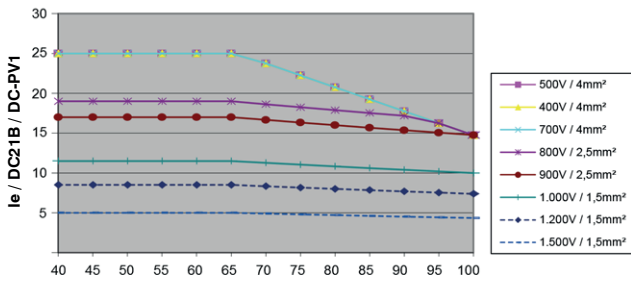

Ambient temperature around the switch (°C)

Switch open LS25 ..., 2 contacts in series + 2 parallel (A2+2)

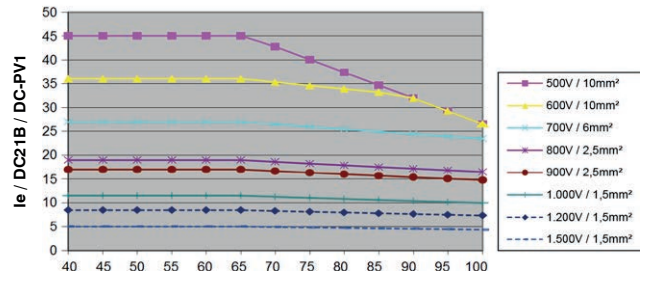

Ambient temperature around the switch (°C)

Switch open LS25..., 4 contacts in series (A4x)

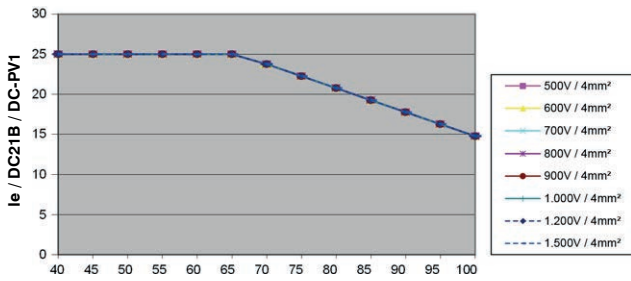

Ambient temperature around the switch (°C)

Switch open LS25 ..., 4 contacts in series + 2 parallel (A4+2)

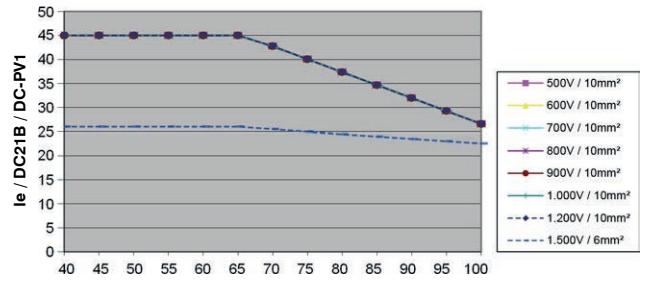

Ambient temperature around the switch (°C)

Switch enclosed LS25 PFL..., 2 contacts in series (A2)

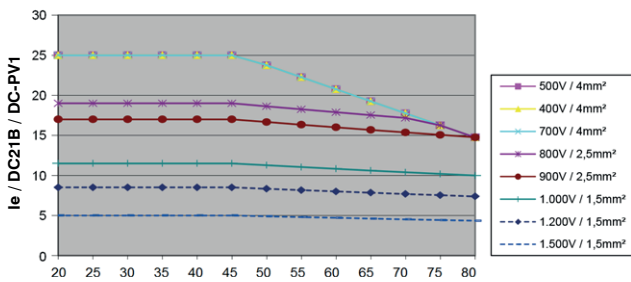

Ambient temperature around the switch (°C)

Switch enclosed LS25 PFL..., 2 contacts in series + 2 parallel (A2+2)

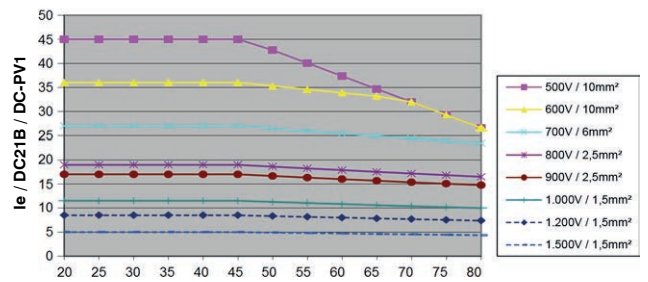

Ambient temperature around the switch (°C)

Switch enclosed LS25 PFL..., 4 contacts in series (A4x)

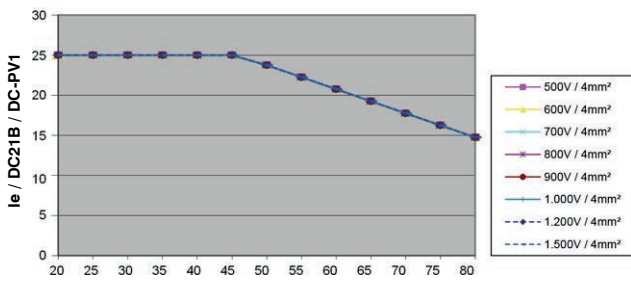

Ambient temperature around the switch (°C)

Switch enclosed LS25 PFL..., 4 contacts in series + 2 parallel (A4+2)

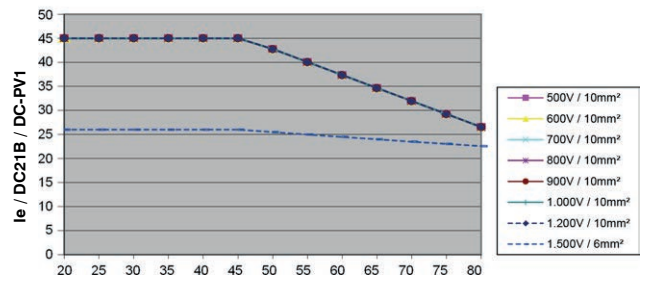

Ambient temperature around the switch (°C)

Technical Datas

Maximum current according to ambient temperature and cable cross section

Switch open LS32..., 2 contacts in series (A2)

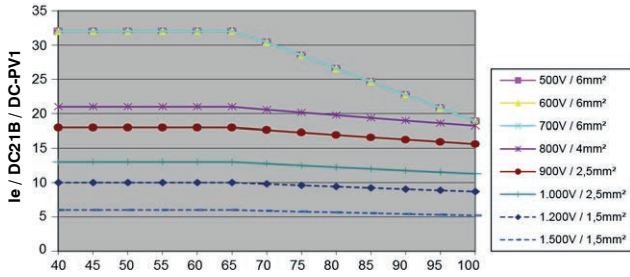

Ambient temperature around the switch (°C)

Switch open LS32 ..., 2 contacts in series + 2 parallel (A2+2)

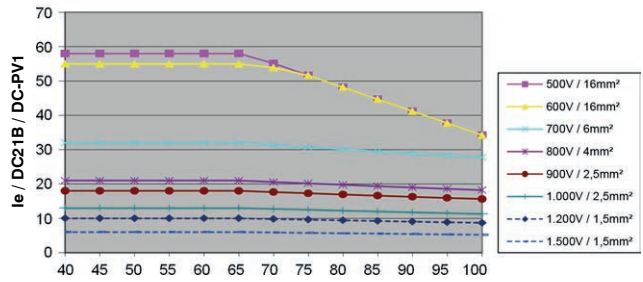

Ambient temperature around the switch (°C)

Switch open LS32..., 4 contacts in series (A4x)

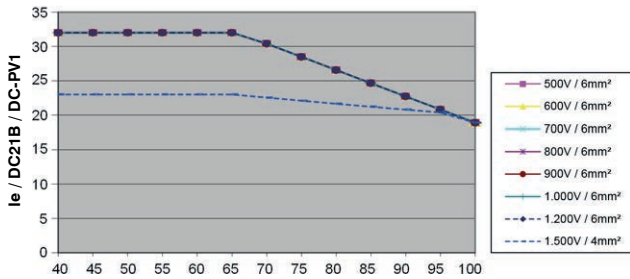

Ambient temperature around the switch (°C)

Switch open LS32 ..., 4 contacts in series + 2 parallel (A4+2)

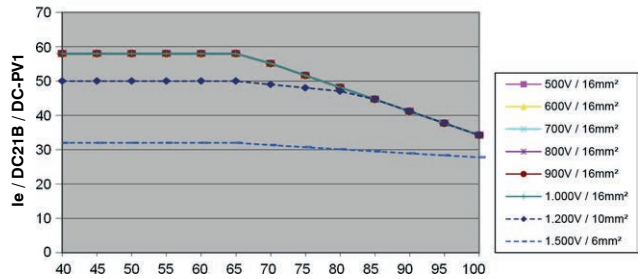

Ambient temperature around the switch (°C)

Switch enclosed LS32 PFL..., 2 contacts in series (A2)

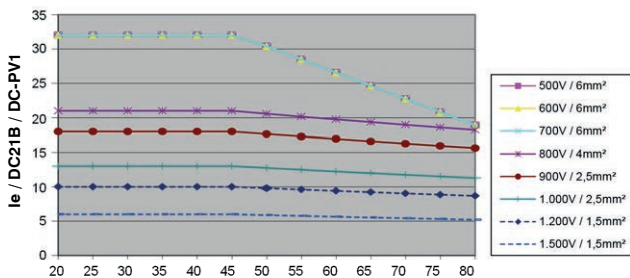

Ambient temperature around the enclosed switch (°C)

Switch enclosed LS32 PFL..., 2 contacts in series + 2 parallel (A2+2)

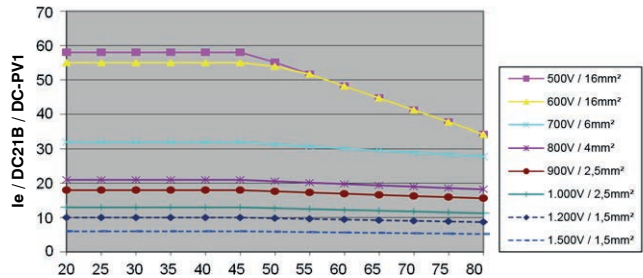

Ambient temperature around the enclosed switch (°C)

Switch enclosed LS32 PFL..., 4 contacts in series (A4x)

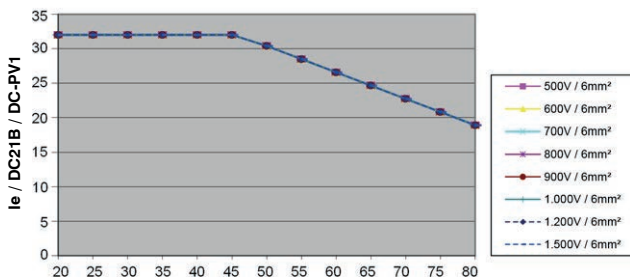

Ambient temperature around the enclosed switch (°C)

Switch enclosed LS32 PFL..., 4 contacts in series + 2 parallel (A4+2)

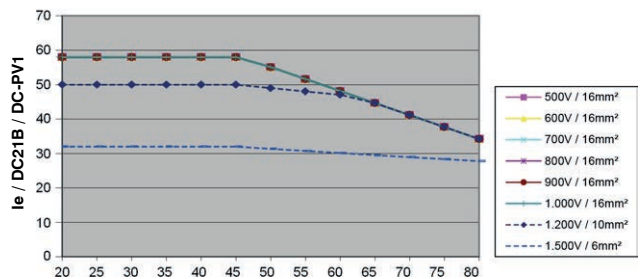

Ambient temperature around the enclosed switch (°C)

Technical Datas

Maximum current according to ambient temperature and cable cross section

Switch open LS40..., 2 contacts in series (A2)

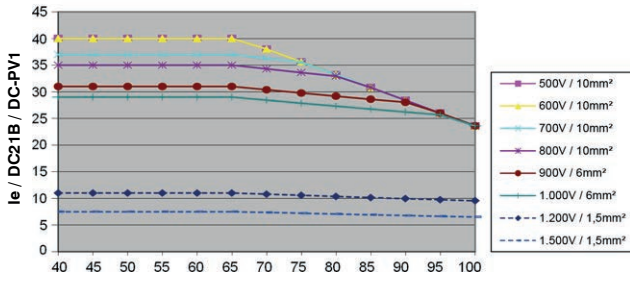

Ambient temperature around the switch (°C)

Switch open LS40 ..., 2 contacts in series + 2 parallel (A2+2)

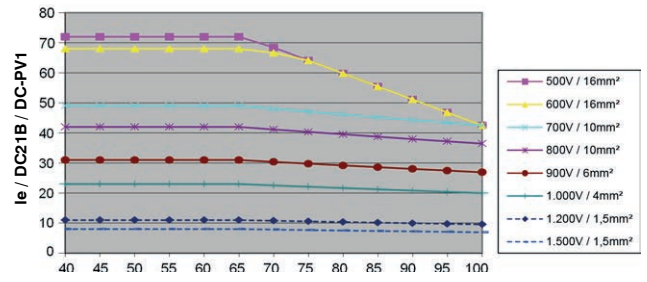

Ambient temperature around the switch (°C)

Switch open LS40..., 4 contacts in series (A4x)

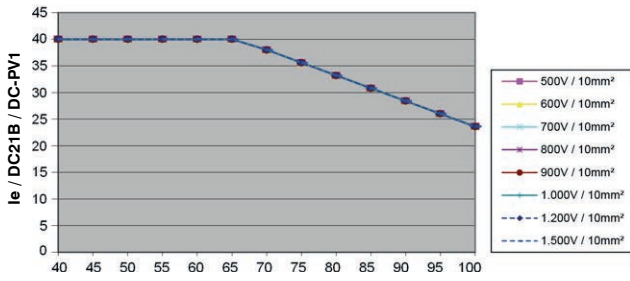

Ambient temperature around the switch (°C)

Switch open LS40..., 4 contacts in series + 2 parallel (A4+2)

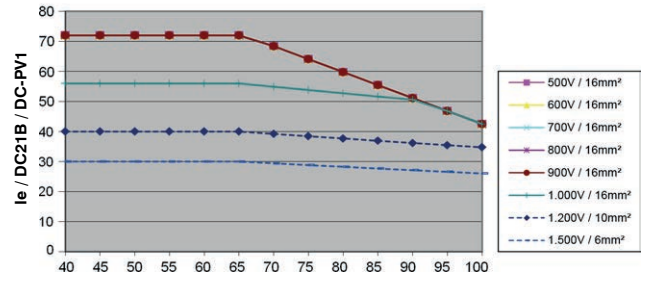

Ambient temperature around the switch (°C)

Switch enclosed LS40..., 2 contacts in series (A2)

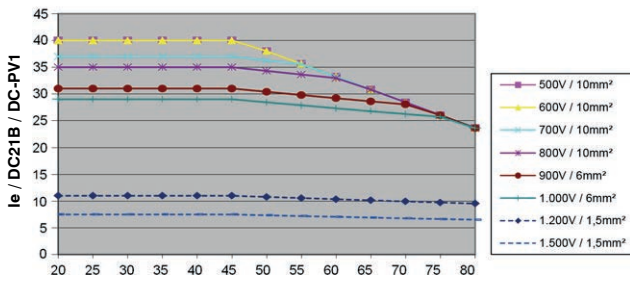

Ambient temperature around the switch (°C)

Switch enclosed LS40..., 2 contacts in series + 2 parallel (A2+2)

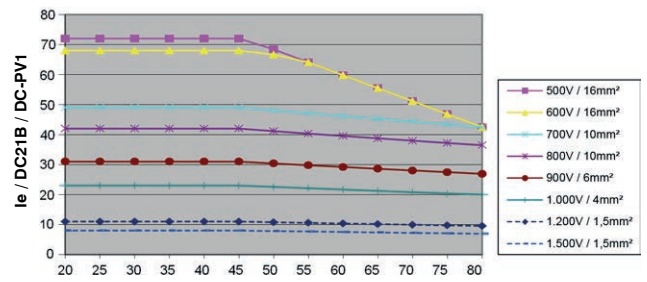

Ambient temperature around the switch (°C)

Switch enclosed LS40PFL..., 4 contacts in series (A4x)

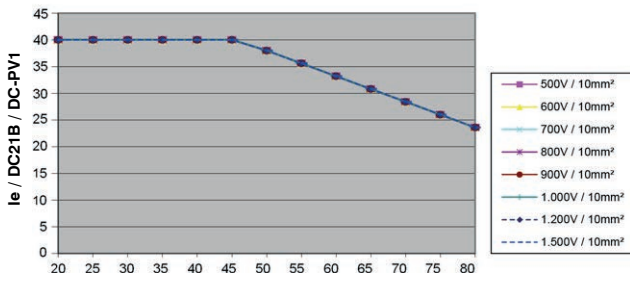

Ambient temperature around the switch (°C)

Switch enclosed LS40PFL..., 4 contacts in series + 2parallel (A4+2)

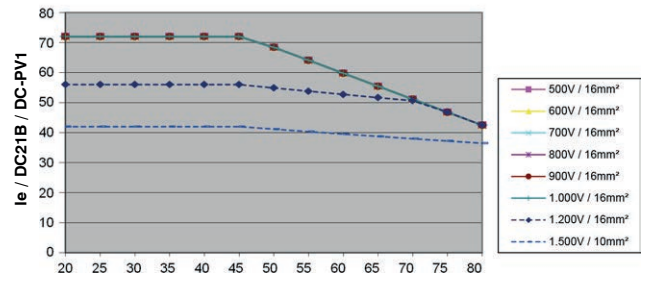

Ambient temperature around the switch (°C)

Technical Datas

Maximum current according to ambient temperature and cable cross section

Switch open LS55..., 2 contacts in series (A2)

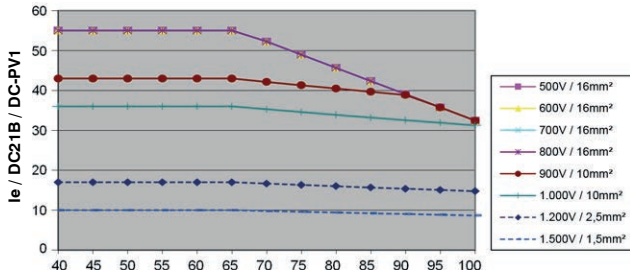

Ambient temperature around the switch (°C)

Switch open LS55..., 2 contacts in series + 2 parallel (A2+2)

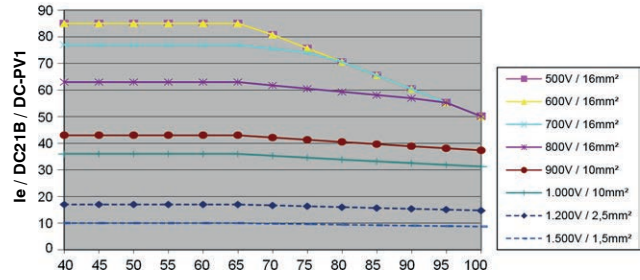

Ambient temperature around the switch (°C)

Switch open LS55..., 4 contacts in series (A4x)

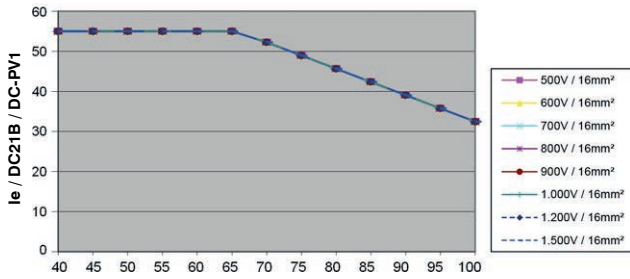

Ambient temperature around the switch (°C)

Switch open LS55..., 4 contacts in series + 2 parallel (A4+2)

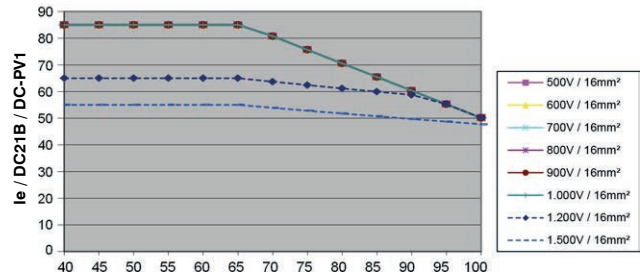

Ambient temperature around the switch (°C)

Switch enclosed LS55..., 2 contacts in series (A2)

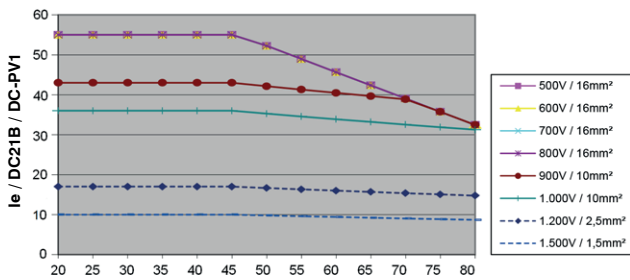

Ambient temperature around the switch (°C)

Switch enclosed LS55..., 2 contacts in series + 2 parallel (A2+2)

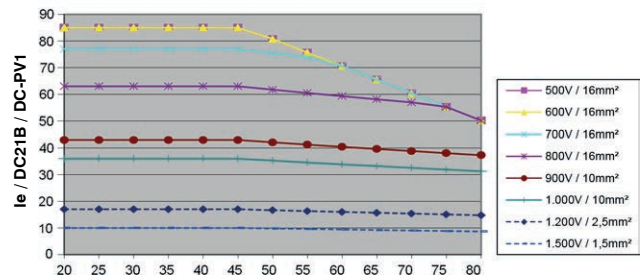

Ambient temperature around the switch (°C)

Switch enclosed LS55PFL..., 4 contacts in series (A4x)

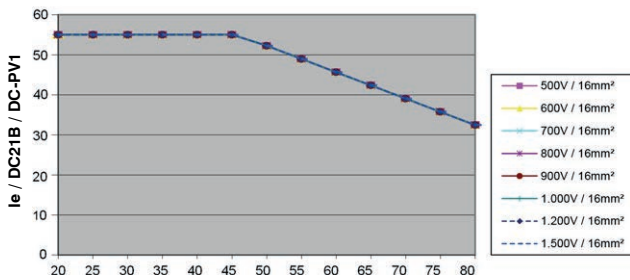

Ambient temperature around the switch (°C)

Switch enclosed LS55PFL..., 4 contacts in series + 2 parallel (A4+2)

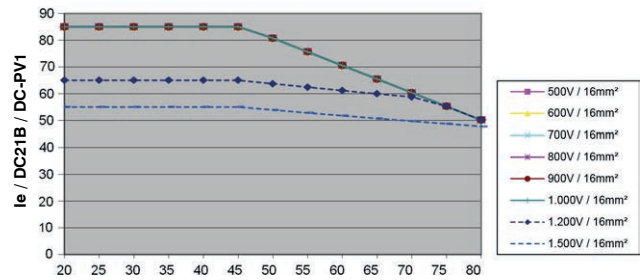

Ambient temperature around the switch (°C)

Dimensions

LS16 E.., LS25 E.., LS32 E.., ..A2
..A2+2, ..A4.

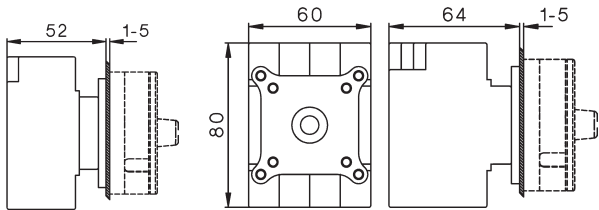

LS16 E.., LS25 E.., LS32 E.., ..A6, ..A8, ..A3+2, ..A4+2

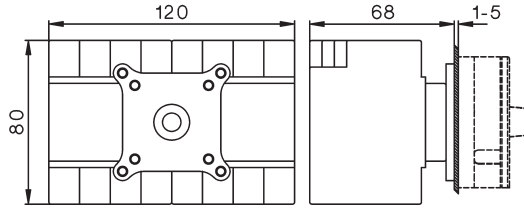

LS... +VW“x“
Extended Switch Shaft

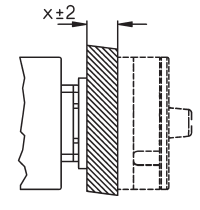

LS40 E.., LS55 E..
..A2, ..A2+2, ..A4.

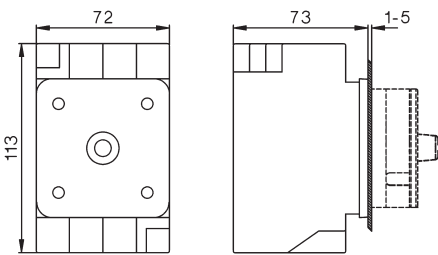

LS40 E.., LS55 E..
..A6, ..A8, ..A3+2, ..A4+2

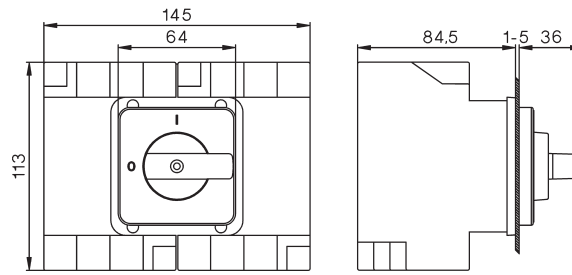

Mounting hole
Mounting screw:
S3631N M=1,2-1,4 Nm

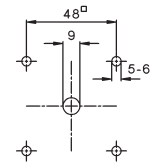

Escutcheon plate 64[□]

Handle

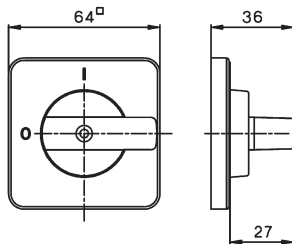

Padlock device SV1.

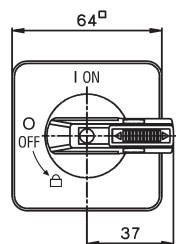

Padlock device SV4.

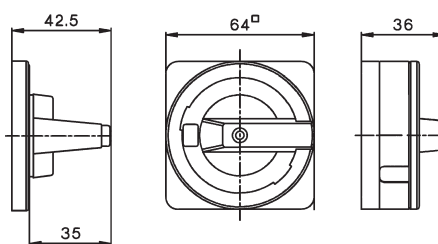

LS16 Z.., LS25 Z.., LS32 Z.., ..A2

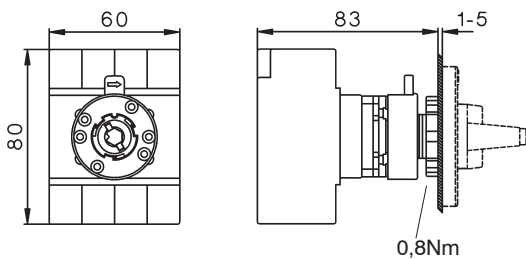

..A2+2, ..A4.

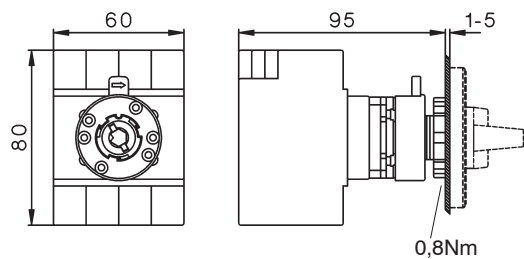

Mounting hole

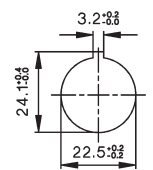

Escutcheon plate 48[□]

Handle

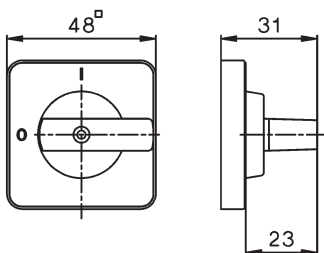

Padlock device SV1.

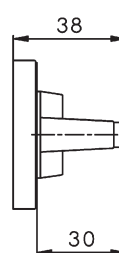
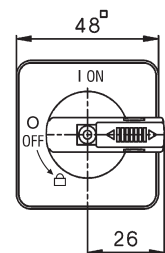

Dimensions

LS16 Z.., LS25 Z.., LS32 Z..,
..A6, ..A8, ..A3+2, ..A4+2

LS.. ZO..

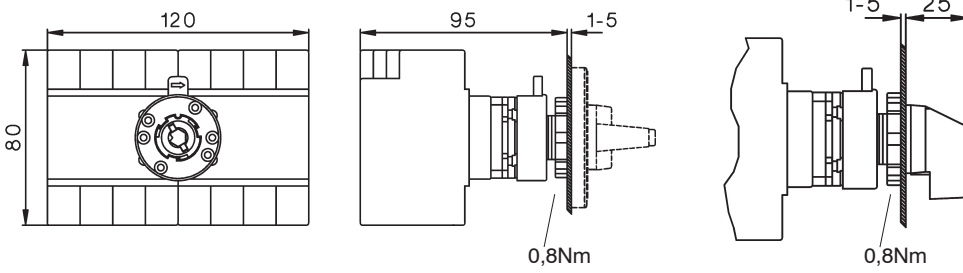

LS16 VZV.., LS25 VZV.., LS32 VZV..,
..A2, ..A2+2, ..A4

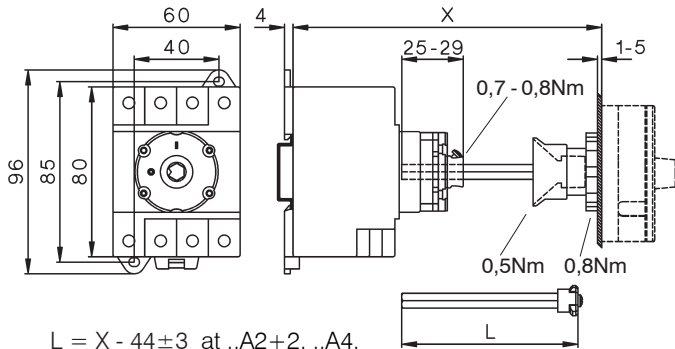

delivered with: ..A2+2, ..A4.
 $X_{max} = 194, L = 150$
($X_{min} = 89$)

delivered with: ..A2
 $X_{max} = 182, L = 150$
($X_{min} = 77$)

Bigger X-Dimensions on request

$L = X - 44 \pm 3$ at ..A2+2, ..A4.
 $L = X - 32 \pm 3$ at ..A2

LS16 VZV.., LS25 VZV.., LS32 VZV..,
..A6, ..A8, ..A3+2, ..A4+2

Mounting hole

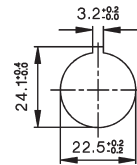
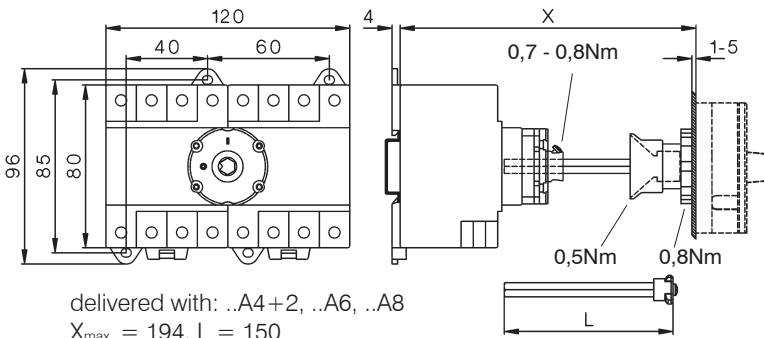

delivered with: ..A4+2, ..A6, ..A8
 $X_{max} = 194, L = 150$
($X_{min} = 95$)

$L = X - 49 \pm 3$

LS40 VZV.., LS55 VZV..
..A2, ..A2+2, ..A4.

LS40 VZV.., LS55 VZV..
..A6, ..A8, ..A3+2, ..A4+2

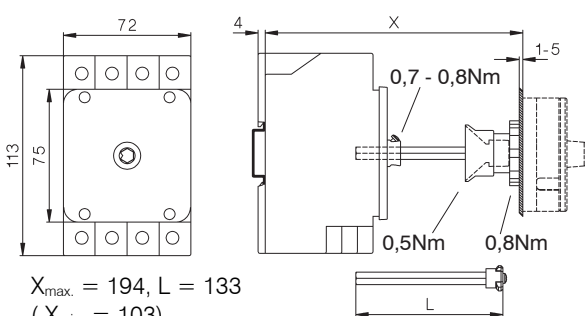

$X_{max} = 194, L = 133$
($X_{min} = 103$)

$L = X - 61 \pm 3$

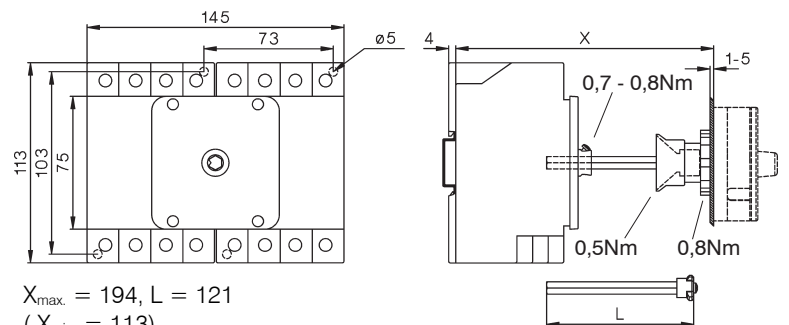

$X_{max} = 194, L = 121$
($X_{min} = 113$)

$L = X - 73 \pm 3$

Dimensions

LS16 SMA..., LS25 SMA..., LS32 SMA..., ..A2

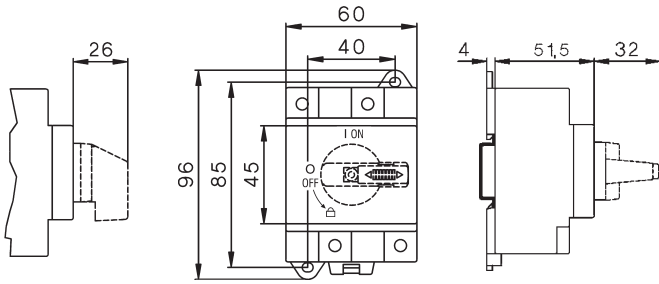

..A2+2, ..A4.

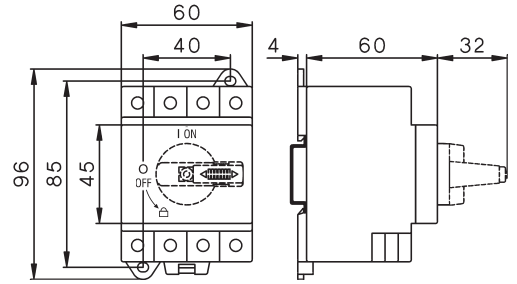

LS40 SMA..., LS55 SMA.. ..A2, ..A2+2, ..A4.

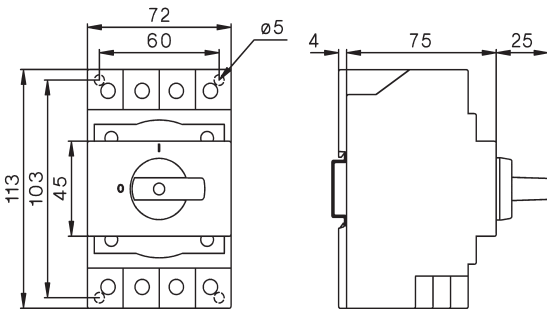

LS40 SMA..., LS55 SMA.. ..A6, ..A8, ..A3+2, ..A4+2

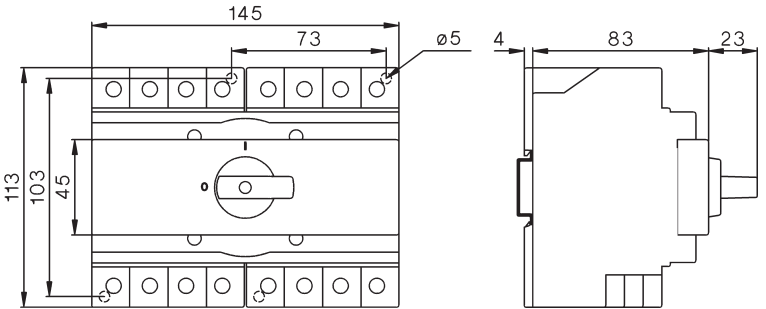

LS16 SMA..., LS25 SMA..., LS32 SMA..., ..A6, ..A8, ..A3+2, ..A4+2

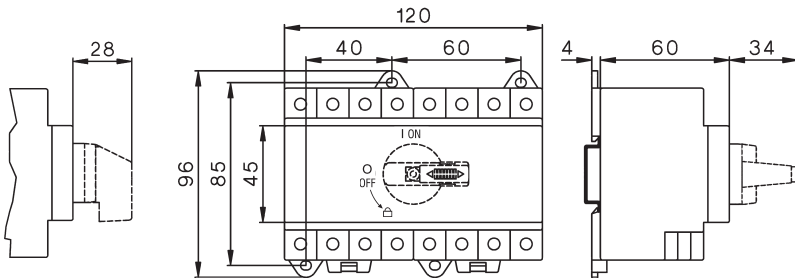

LS.. SMAH1.. with low height handle A2+SV1N

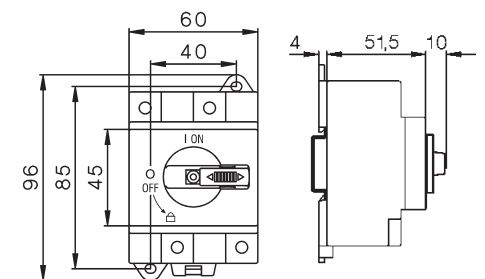

LS16 SMAH1..., LS25 SMAH1, LS32 SMAH1 with low height handle A2+2 +SV1N, A4.+SV1N

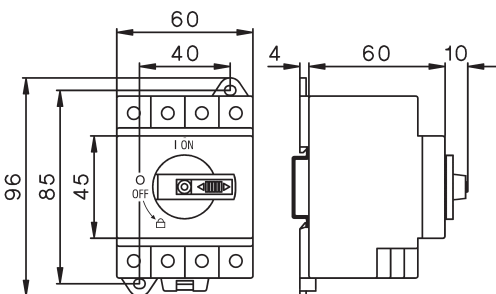

A4+2 +SV1N, A6+SV1N, A8+SV1N

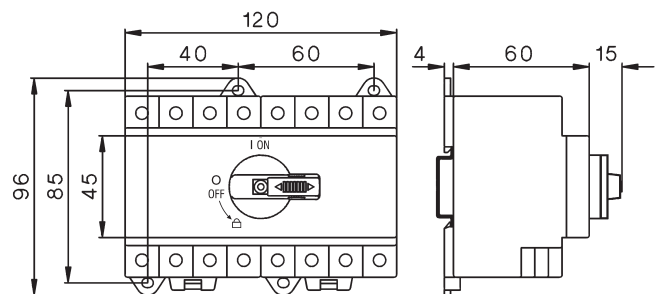

Dimensions:

LS16 PFL..., LS25 PFL..., LS32 PFL..
..A2, ..A2+2, ..A4.

Main-Switch (lockable)
LS..PFLH4 A..

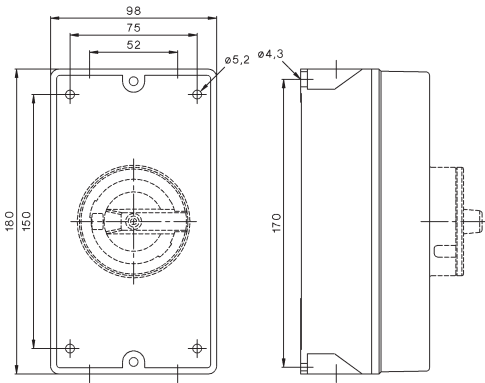
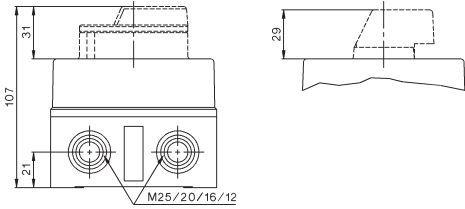

LS16 PFL..., LS25 PFL..., LS32 PFL..
..A2, ..A2+2, ..A4.
+ M25

Main-Switch (lockable)
LS..PFLH4 A..

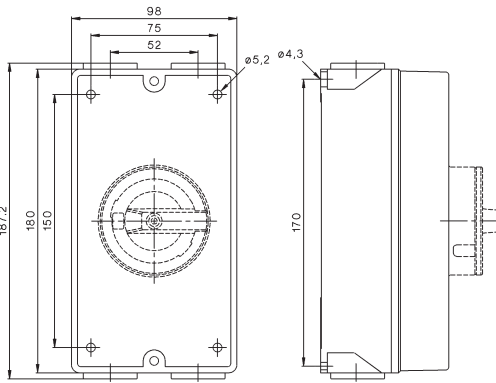
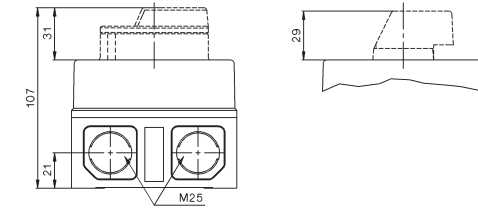

LS16 PFL..., LS25 PFL..., LS32 PFL.. LS40 PFL..., LS55 PFL..
..A6, ..A8, ..A3+2, ..A4+2 ..A2, ..A4, ..A6, ..A8, ..A2+2, ..A3+2, ..A4+2
Main-Switch (lockable)
LS..PFLH4 A..

